

INSTRUCTION MANUAL

BS350/60 AFI-NC Automatic Hitch Feed Metal Cutting Band Saw (415V) 350 x 200mm (W x H) Rectangle

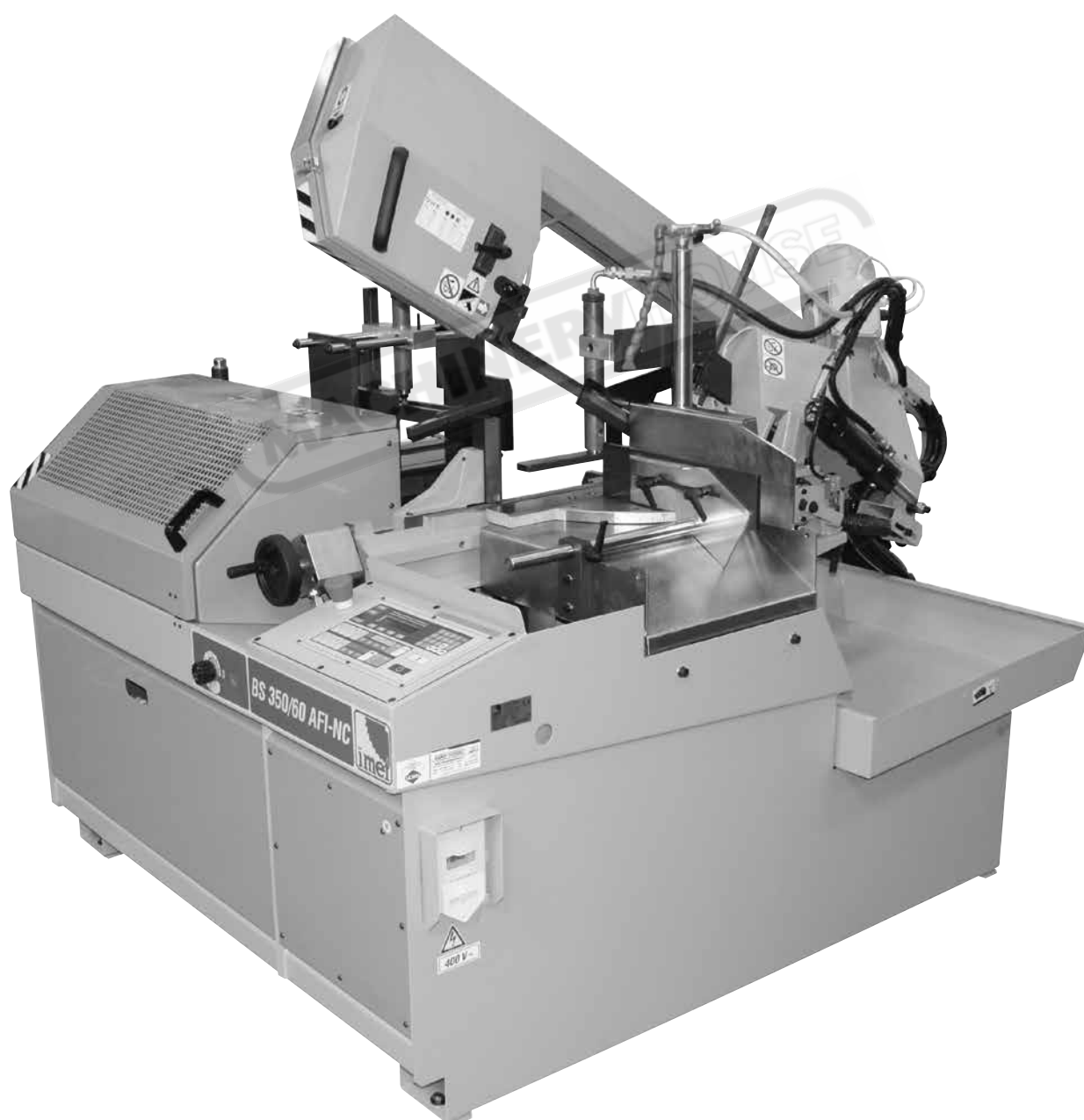

B106

B106

GO TO

15-4-09 (HAFCO TRANSLATION)

INSTRUCTIONS FOR USE

By using the function GTO it is possible to move the work piece by a determined measure and then to cut it:

This is done in a few operations

Programming the rear vice to move back to the required length, clamping the workpiece in the rear vice
Then moving the rear vice to "0" (This brings the work piece fwd to the required length)
Then cutting the workpiece

TO DO THIS

Set the workpiece up to blade or perform a trim cut (See Semi Automatic Cycle operation)

- # Clamp the front vice, Unclamp the rear vice
- # Press the button under GTO on the display, (F4)
- # Enter the measure in mm (to cut 55mm type in 55)

Press the white cycle start button 

The feeder will move the rear vice to the chosen measurement

- # Clamp the rear vice and open the front vice
- # Press the button under GTO on the display, (F4)
- # Enter the measurement "0"
- # Press the white cycle start button 

The work piece will now feed to the initial length ready to cut.

To cut: Press the white button-31/R10408-1 (the front vice will close and the saw will cut the work piece and return)

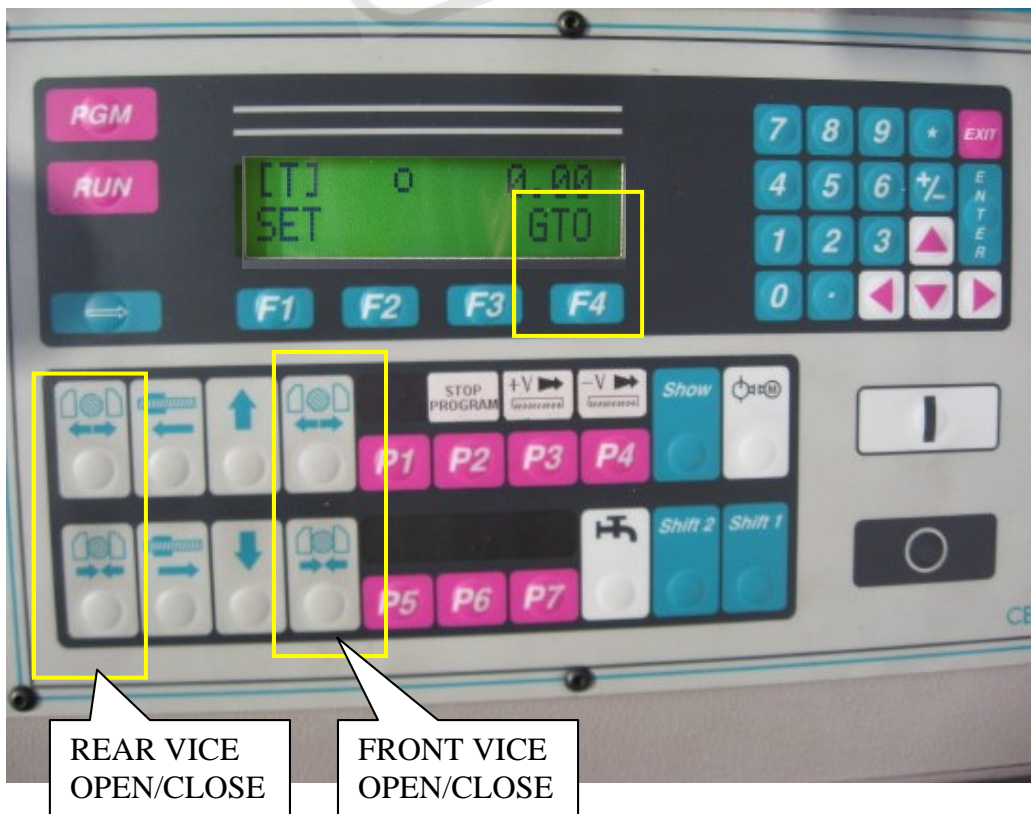

At the first use of the machine or if the feed vice is moved with the machine switched of.
 We advise that the "HOME" setting of the feeder is set,
 Start hydraulics While the vices are opened and without any material in the saw and saw frame up,
 Press "F1 Press "AZZ", then enter PASSWORD " 963852 " and press ENTER.
 Then press "F1"

Finally the white button START



Machine will "Home" the feeder

To check the machine functions

Put the workpiece on the worktable.

With the front and rear vice in the hydraulic open position, wind in the vice jaws to about 2-3 mm between the material and the jaws,(necessary for the automatic closing of the vice)

Lock the 2 x vice leadscrews (See "Locking Vice lead screws")

The workpiece has to be positioned slightly infront of the cutting line.

Turn on the hydraulics

Close the front vice by pressing the front vice close button

!!!! Be sure that the material is effectively clamped by the jaws and that the closing pressure is suited, that is, it doesn't cause any deformation to it.

Ensure the front movable blade guide assemble is adjusted in as close as possible with out interfering with the vice jaws

Select the blade speed, the coolant flow (continuous, only during the working cycle, off),

Push the white cycle Start button



Adjust the coolant flow on the blade by means of two taps, and, after the quick motion of the saw frame, begin the cut and possibly adjust the blade speed "P3" or "P4" .

At the end of the cut the saw frame returns back and stops.

This cycle has to be used for trim cuts and for single cuts.

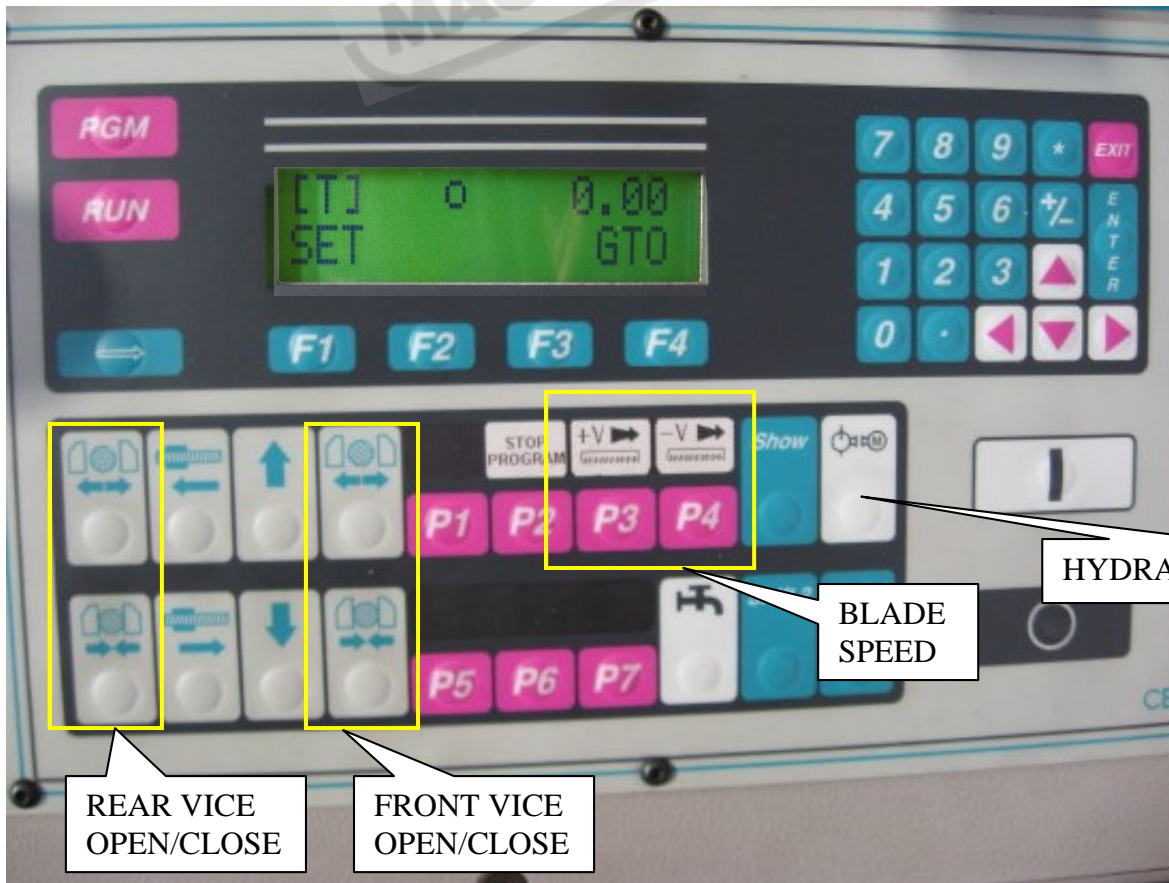

B106 - AUTOMATIC CYCLE — 3 (HAFCO TRANSLATION)

To create cutting programs is necessary in order to perform automatic cutting cycles.

At the first use of the machine or if the feed vice is moved with the machine switched of.
 We advise that the "HOME" setting of the feeder is set,
 Start hydraulics While the vices are opened and without any material in the saw and saw frame up,
 Press "F1 Press "AZZ", then enter PASSWORD " 963852 " and press ENTER.
 Then press "F1"

Finally the white button START

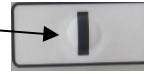

Machine will "Home" the feeder

Firstly set up work piece and vice jaws
 # put the work piece on the worktable.

With the front and rear vice in the hydraulic open position, wind in the vice jaws to about 2-3 mm between the material and the jaws,(necessary for the automatic closing of the vice)

Lock the 2 x vice lead screws (See "Locking Vice lead screws")

The work piece has to be positioned slightly in front of the cutting line.

Close the front vice

!!!! Be sure that the material is effectively clamped by the jaws and that the closing pressure is suited, that is, it doesn't cause any deformation to it.

Ensure the front movable blade guide assemble is adjusted in as close as possible with out interfering with the vice jaws

AUTOMATIC CYCLE

Ensure hydraulics is Running

NB: To check the machine functions, you can use the program already memorized

Or create a new one, by completing the following steps:

Push the Pink PGM button then the button F1 below the word NEW which appears on the display
 (the other words have this meaning: EDIT= Edit the existing program, DEL= Delete program , CA=cancel only one line of the program)



The following inputs will need entering.

Enter in the option of operation after each cut "M" Press the blue ENTER' button on the far right

options "0" = machine continues its Cycle after each cut

"1" = machine stops after each cut and the cycle start and  button must be pressed to continue the cycle

"2" = ??????????????????

Enter in the length of the cut to make, "L". Press the blue ENTER' button on the far right.

Enter in the quantity on cuts to make, "Q". Press the blue ENTER' button on the far right.

Push Exit if there is no other data to dial in or ENTER again to insert other cutting lengths and related number of cuts — for a maximum of 10 different types.

This allows the machine on the one Cycle to cut for example 13 pieces 10mm long and then 2 pieces 45mm long and then 15 pieces 234mm long etc up to 10 different lengths and quantities

RUNNING A PROGRAM

Push PINK RUN button.

Existing programs will be shown above the word "RUN" on the display

To select the one you want arrow across using the pink arrow buttons.

To start the selected program press "F1" button under the word RUN on the display

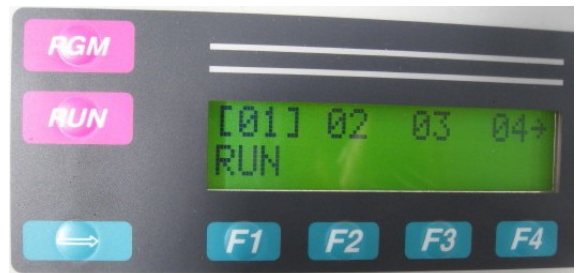

The display will show the programs initial first line set up

" L" being length of cut " N " being number of cuts and " M" being cycle configuration



Push the white cycle Start button



You will be prompted to select if you want to do an initial face cleaning cut to true up or set the end of the workpiece. Press either "F1" or "F2" as needed.

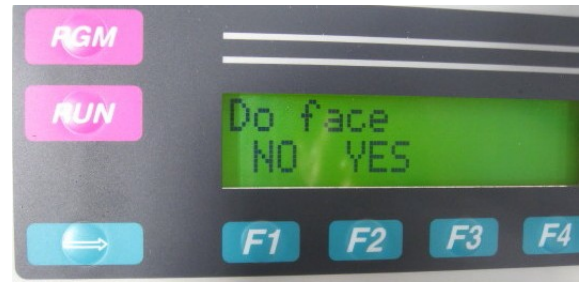

The machine will now perform its Cycled program

Adjust the coolant flow on the blade by means of two taps, and, after the quick motion of the saw frame, begin the cut and possibly adjust the blade speed "P3" or "P4" .

Select the blade speed, the coolant flow (continuous, only during the working cycle, off),

DURING THE AUTOMATIC CYCLE THE PRESENCE OF THE USER IS NOT NECESSARY OR CAN BE LIMITED TO SUPERVISING THE PROCESS.

At the end of the working cycle the machine stops waiting for the zero setting of the piece counter or the start of a new cycle, The display shows END PROGRAM.

At the end of each bar the handsaw stops, waiting for a new bar to be loaded.

Take away what is left of the previous bar and place the new one just beyond the cutting line, start the program again and make the trim cut — which is not counted.

MACHINERYHOUSE

INSTRUCTIONS FOR USE

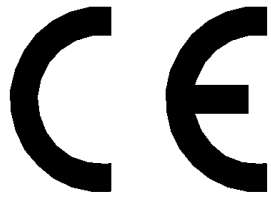
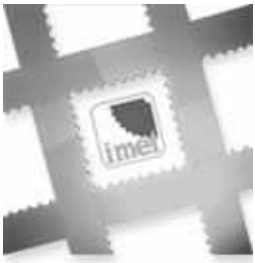

Automatic hydraulic bandsaw BS350/60 AFI-NC with Numerical Control

INSTRUCTIONS FOR USE



INSTRUCTIONS FOR USE





We recommend to read carefully the information here included in order to install, use and maintain correctly and safely this machine.

Please refer always to this instruction manual in case of assistance service need and keep it carefully for all the machine life.

A consequence of the continuous improvement of the product is that some images/descriptions here included could not correspond to the improved features of the machines. Your kind collaboration would help us in intervening immediately.

In the enclosed Compliance Declaration you will find the Safety and Reference Norms applied during the planning and construction of this machine. The choice and the use of the parts have been made considering the conditions of use and the long machine life.

The identification plate, with the serial number, is placed on the side of the machine or on the control panel

<p>RI0445</p> <p>MACCHINA/MACHINE</p>	 <p>Localita' 3 Fontane Cisano Bergamasco 24034 -BG- Italy Tel. +39 035787833 Fax. +39 035787066</p>  <p>072304=BS300/60 AFI-E/ESC 18>110 M/1 NEWAUT 400V-3-50HZ 2765X27 2006 MATRICOLA N. SERIAL NUMBER 061065001</p>
<p>DICHIARAZIONE CE/ CE DECLARATION</p>	<p>072304=BS300/60 AFI-E/ESC 2006 18>110 M/1 NEWAUT 2765X27 400V-3-50HZ 061065001</p> 
<p>IMBALLO/PACKING</p>	<p>072304=BS300/60 AFI-E/ESC 2006 18>110 M/1 NEWAUT 2765X27 400V-3-50HZ 061065001</p> 

1.1 - ATTACHED DOCUMENT FOR E.M.C. (INDUSTRIAL ENVIRONMENT)

The user is responsible for the installation and use of this machine in compliance with the manufacturer's instructions shown in this manual. This equipment meets the protection requirements in accordance with the Directives 89/336/EEC, 92/31/EEC e 93/68/EEC as for Electromagnetic Compatibility (EMC). In particular, it follows the technical guidelines of the Directives EN55011, EN50082-2 and it has been made for industrial and not for household use.

In the event of electromagnetic interferences the user is responsible for solving the problem with the help of the technical assistance by the manufacturer. Before installing the machine the user must take into account possible electromagnetic problems of the working area. In particular, we suggest to install the machine away from:

- signalling, control and telephone cables;
- radio-television transmitters and receivers;
- computers or controlling and measuring instrument;
- safety and protection devices.

The electric supply cable must be kept as short as possible, without any twists.

Covers, doors and the frame must be suitably closed when the saw is operating.

Under no circumstances the machine must be modified except for adjustments and changes specifically approved by the manufacturer. Follow the maintenance schedule.



DECLARATION OF CONFORMITY

According to the law that reproduces the Machine Directives

MANUFACTURER: IMET S.p.A.
Località Tre Fontane
24034 - CISANO BERGAMASCO (BG) - ITALY

HEREBY DECLARES THAT

in designing and manufacturing the machine described here below, we have observed the most important requirements of safety and health dictated by the European Directives of Machine Safety.

Don't forget that this declaration loses its validity if the machine is modified without our approval.

BANDSAW FOR CUTTING METALS

Code / Model / Type

Manufacturing year

Serial number

THE ORIGINAL DECLARATION IS ON THE MACHINE

Reference Directives: Machine Directives (89/392/CE) in the versions
91/368/CE, 93/44/CE, 93/68/CE, 98/37/CE.

Low Tension Directive (73/23/CE), Directives 2006/95/CE, 2002/95/CE, 2002/96/CE, 2003/108/CE.
Electromagnetic Compatibility (89/336/CE)
in the versions 92/31/CE, 93/68/CEE, 2004/108/CE.

Norms Applied: EN 292-1 and EN 292-2; EN 60204-1, EN 13898
EN 414, EN 418, EN 55011, EN 50082-2

Date : 01.01.2008

The signatory identification

The manager

Angelo Meroni

File: Machine no. Delivery note no dated

INSTRUCTIONS FOR USE



3 - MACHINE NOISE

The noise level of the working area - given the conditions described below - is determined by the simultaneous working of several parts of the machine in motion (according to the working cycle), in addition to the tool when cutting the material.

The noise level is detected in different moments, corresponding to different working phases. **The proper device is placed about 1 meter near the machine and about 1,60 m above the floor. The results of each test is in dBA and they are the average of 3 tests made from the left side, opposite side and right side.**

For any machines the working conditions are the following:

When idle, at the maximum blade speed: dBA 63

During the cut, at a suited blade speed, cutting solid steel (St12≈C20, 80mm diameter): dBA 75
(tolerance ± 2 dB).

In the standard production the test is made on a machine like this, in compliance with E.C. safety norms 89/392/CEE and 86/188/CEE. Using the saw in bad conditions or using wrong tools causes significant alterations of these tests and it jeopardizes the health of the staff and the good results of the work.

The noise depends mostly on the cutting material, on its size and on the clamping. Considering that the above mentioned decibels could be exceeded, we recommend the operator to use personal protections (headsets, plugs, and so on) when working for a long time with high noise levels.



3.1 - ADDITIONAL HEALTH AND SAFETY REQUIREMENTS

The machines manually controlled by an operator during all work phases must comply to further health and safety requirements as specified by article 2.2 of the Annexed I of the European Directive 89/392 and following integrations. In particular, the level of the machine vibrations when working must be clearly specified in the instructions.

This machine does not produce vibrations higher than 2.5 m/s²

The measurement procedure is in compliance with the general norms applied to this type of machinery.

As in the previous paragraph, using the machine in unsuitable conditions or using the wrong tools can cause changes affecting this value, causing a risk to the health of the working staff as well as the quality of the production.

Vibrations produced during the cut may be amplified by the material, by its dimensions and its positioning/clamping in the vice.

INSTRUCTIONS FOR USE

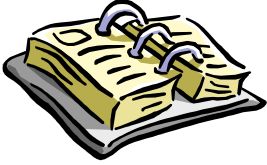

4 - GUARANTEE NORMS

I.M.E.T. offers a wide range of sawing machines and accessories, destined to who buys/uses them as part of a commercial or professional activity.

The manufacturer grants that this product has been strongly controlled and that there are no defects in the used and working materials for a period of 12 months from the date of the delivery note.

The Italian law D.L. n°24 issued on 02/02/2002 and valid since 23/03/2002 (which carries out the European Directive 1999/44/CE) indicates different terms only for convenience products for private use.

If the user points out some defects to the manufacturer during the warranty time, the manufacturer will replace the components that are considered faulty.

In case of reparation of the machine during the warranty time the shipment will be accepted only if the delivery is Free Destiny (that is the freight costs are supported by the owner of the machine), and the return of the machine to the customer is considered EX WORKS.

If the manufacturer is not able to replace a component within an acceptable time, both companies (manufacturer and user) will reach an agreement to satisfy completely the needs of the user.

The a.m. warranty is not valid in case of accidental damages, or defects provoked by a wrong use or maintenance of the machine, by variations made on the equipment, or by the use of the machine in a place not corresponding to the indicated environmental specifications.

4.1 - The manufacturer does not offer further warranties, written or spoken, explicit or implicit of its products and does not offer implicit warranties on suitability for particular uses not foreseen by the agreement or on chances of selling them.

The a.m. limitations and exclusions can also be not applicable in Countries, where there are no implicit limits of warranty time on the products. Anyway each implicit warranty is limited to a time of 12 months from the date of the delivery note.

4.2 - The date of manufacture, which can be evinced from the serial number placed on the machine, is a necessary reference for warranty, after-sale assistance and product identification.

Each modification of the products, especially the installation of safety devices, will relieve the manufacturer of any kind of responsibility.

The parts most subject to rapid and continuous wear are not included in the warranty (for example: transmission belts, gaskets, oil, blades, and so on).

For electrical, electronic and hydraulic equipments and for all other equipment having its own specifications (whereas the name of the manufacturer is known), the manufacturer gives to the user the same warranty received by the primary manufacturer of these parts.

4.3 - The components replaced during the assistance provided by the manufacturer have a **warranty of 6 months** from the installation date indicated on the Technical Service paper, one copy of which is given to the owner.

INSTRUCTIONS FOR USE

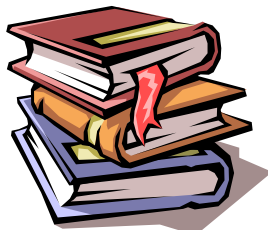

5 - SUMMARY

pag.

1- INTRODUCTION	2
2 – CONFORMITY DECLARATION	3
3 – MACHINE NOISE	4
4 – GUARANTEE NORMS	5
5 – <i>Index</i>	6
6 – <i>Technical Features</i>	7



7 – *Installation – minimum requirements*

9

8 – <i>Moving and shipping</i>	9
9 – <i>Fittings/Accessories</i>	11
10 – <i>Blade choice</i>	12
11 – <i>Instructions for use and warnings</i>	14
12 – <i>Machine description</i>	17
13 – <i>Machine Set-up</i>	18
14 – <i>Blade tension</i>	19
15 – <i>Drivers Description</i>	20



16 – *Adjustments*

25

17 – <i>Maintenance – for the user</i>	27
18 – <i>Blade Run-in</i>	28
19 – <i>Machine Run-in</i>	28
20 – <i>Draining of used/produced substances</i>	29



21 – *Trouble-shooting*

29



22 – *Machine demolition*

31

23 – <i>Spare parts</i>	32
-------------------------	----

24 – <i>Maintenance – for qualified technicians</i>	33
---	----

- Electrical drawings*
- Hydraulic diagram*
- Spare Parts drawings*

INSTRUCTIONS FOR USE

6 – TECHNICAL FEATURES

Automatic electronic bandsaw with numeric control and hydraulic working, suitable for cutting metal profiles and solids from 0 to 60 deg. left in automatic cycle and in semiautomatic cycle. Material feeder equipped with recirculating-ball screw and self-braking electric motor. In compliance with E.C. - CSA - UL Safety Norms and with the Norms of Electromagnetic Compatibility (EMC).) The new control panel allows to set up and memorize up to 10 programs, each one with 10 programmable cutting lengths and number of cuts. The LOOP option allows to repeat several times the same program, even when changing the material size.

STANDARD MODEL EQUIPPED WITH:

1,8 Kw Three-phase motor, controlled by an Inverter - ESC - with blade speed from 18 to 100 m/min - electrical components complying with E.C. Norm EN60204-1, EN55011, EN50082-2, low voltage (24V), main switch with interlocking attachment and minimum tension coil, thermo-magnetic overload motor protections, emergency stop.

Easy-to-use CNC control; all operating functions of the machine are programmed on the control panel, mechanical device which detects automatically the start-cut point (position sensor).

Working conditions, such as blade speed, piece counter and number of pieces to cut shown on an alphanumeric display, memorization of the cutting lengths (from 4 to 30.000 mm) with automatic repetition of the strokes, working anomalies shown as well.



New blade guard which allows a quick and easy replacement of the blade with adjustment by means of a screw located on the front side of the sawframe; microswitch.



Front fixed hydraulic vice, jaws height 160 mm – easy stops at 0°, 45° and 60° left for mitre cutting, graduated plate to identify different angles, feeder that runs on recirculating-ball screws, 350 mm maximum opening, 4 mm minimum stroke, 80 mm minimum scrap-end, incremental advancement with automatic correction for the blade thickness. Feeder vices fitted on a mobile plate, motion by means of chromed and hardened guides.





Connection for loading tables, unloading slide/adapter for unloading table - removable chip tank, coolant pump and washing spray gun, hydraulic unit with oil. New band-cleaning device with brush, bi-metal band, wrenches and instructions manual, maintenance and spare parts.







ⓘ If not differently indicated, all data reported in this manual refer to the standard version, suitable for working at 400 V / 50 Hz THREEPHASE with NEUTRAL WIRE.

 = cutting capacity (max. dimensions on PROFILES & TUBES)

 = BLADE SIZE  = WEIGHT  =VICE OPENING

  = motor choice and blade speeds (at 50 Hz);

				
mm.	Kw	Mt/min	mm.	Kg.
3370x27x0,9	1,8 3~ +N	18/100 (ESC)	350	890

			
	mm.	mm.	mm.
 0°	305	250	350x200
 45°	250	230	230x200
 60°	175	155	170x100

N.B. If the device of MINIMAL LUBRICATION is mounted on the machine, the cutting capacity is reduced by around 10 mm due to the spray nozzles on the anterior band guide.

Size (mm)	B Breadth	L Width	H Height	H Worktable
When working	1850	1900	1990	880

INSTRUCTIONS FOR USE

Packed	1850	1900	1700	
--------	------	------	------	--



7 - INSTALLATION

This machine can work according to the parameters provided by the manufacturer if correctly installed and if the minimum requirements are observed, as follows:

- It must be used indoor and with temperatures from +5 to + 40 °C.
- The relative humidity of the environment must not be over 95%.
- The nominal value of the voltage must be between $\pm 10\%$ and the frequency must be between $\pm 2\%$ of the nominal value.

The floor must have a proper loading capacity and be flat.

Floor space, operator position and working area are indicated in the included drawing that concerns only the bandsaw, without optional accessories.

The worktable must be levelled by using the screws and nuts (not supplied) put in the little feet holes. The machine have also be fixed to the floor .

The included electrical schemes reproduce the necessary details to arrange the connections, to be suited for a 5KW power request and the NEUTRAL WIRE.

Earthing of all the electric parts with a dedicated GREEN/YELLOW wire, connected with a TN system to the supply cable. A supplementary earthing point – indicated with PE – can be located on the metallic structure of the machine.

At the origin of the power supply cables a device (such as fuses) to protect against overloading has to be installed. On the models equipped with electronic variable-speed drive unit (ESC), in order to connect the differential protection on the power supply line, switches with a threshold of interference on the power dissipation of not less than 300 mA (size 0.3 A or higher is recommended) have to be employed, having possibly time adjustment availability ($0 > 1.5$ sec).

E.M.C. - Electromagnetic noise

The user is responsible for installing and using this saw according to the manufacturer's guidelines outlined in this manual. This equipment complies with the protection requirements established by the Directives 89/336/CEE, 92/31/CEE, 93/68/CEE concerning Electromagnetic Compatibility (EMC). It is in compliance also with the technical guidelines of the Norms EN 55011, EN 50082-2 and it is intended for industrial and not for household use.

Before installing the machine the user must take into account possible electromagnetic problems of the working area. In particular we suggest to install the equipment away from:

- signalling, control and telephone cables;
- radio-television transmitters and receivers;

The supply cable has to be as short as possible, with no twists. All doors, coverings and frame have to be closed when the saw is running. Do not make any modifications to the machine except for adjustments and replacements allowed/recommended by the manufacturer. Follow the maintenance schedule.



8 – TRANSPORT & MOVING

For the transport of the machine only the methods indicated below are possible. However, be sure that the means of transport and lifting are able to stand the machine's weight and its packing (about 1000 Kg):

WARNING

The personnel in charge of loading, unloading and moving the machines should use protective gloves.

WARNING

When lifting or moving the machine, or a part of it, take care of clearing the operations area of the people, considering also an appropriate safety area around it, so as to avoid any risks of injuring people or damaging things located nearby.

INSTRUCTIONS FOR USE

Special packing – wooden crate , wooden case –may be arranged on request, with a surcharge.

ALL THE OPERATIONS THAT INVOLVE MOVING THE MACHINE MUST BE CARRIED OUT WHILE FOLLOWING THESE BASIC RULES:

- + When moving the machine, an appropriate means has to be used, with a loading capacity higher than the weight to lift, which is indicated on the machine.
- + When choosing and then using equipment such as ropes, chains or lifting belts, be careful about their geometry during the lifting and about the consequent actual loading capacity.
- + The machine is structured so as to offer lifting points, which are appropriately indicated and will have to be used for lifting it.
- + In case the lifting belts touch parts of the machine, nylon belts are required; ropes or chains wrapped with jute or clean covering can also be used. A great care is necessary while slinging and moving the machine in order to hinder damages.
- + All operations have to be conducted gradually, so as to avoid jolts and dangerous situations.
- + The person in charge of the operations has to make sure that all the national, local and company norms in reference to injury prevention and work safety are respected.
- + One or more areas for material storage have to be identified.

Transport with machine at sight

This type of transport is usually chosen for deliveries by truck, in case of short trips. The machine is wrapped with thermoplastic material in order to assure a suited protection of all its parts; the machine is then loaded on a truck and should be wrapped with ropes that tie it up. To lift it, use a forklift from the front side of the machine, with forks length 1.5 m or more.

Warning: if the machine is loaded on open trucks, please cover them

R10458

**Transport with wooden crate or wooden case. (ON REQUEST , WITH SURCHARGE)**

The saw is wrapped with thermoplastic material in order to assure a suited protection of all its parts; then it is packed into a wooden crate or cage to protect it from collisions, inclement weather and so on. To lift it, use a forklift from front side of machine.

The machine is fixed to the packing by means of screws, so as to hinder that it can move during the transport

INSTRUCTIONS FOR USE

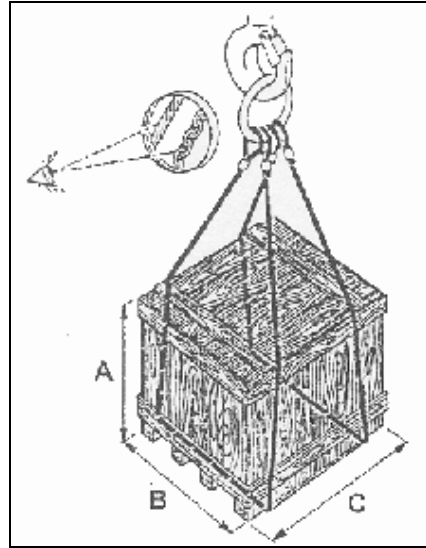
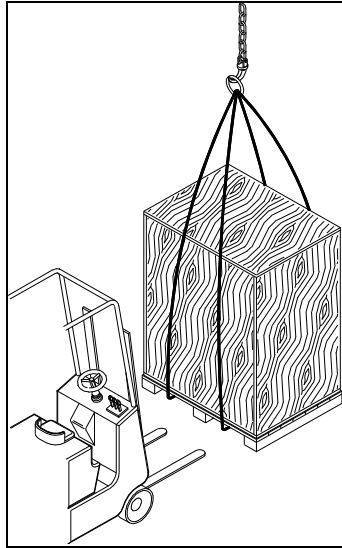

If the saw has to be moved around after being unpacked, make sure the sawframe is all the way down and properly blocked, and the feeder is as close as possible to the cutting area

9 – FITTINGS/ACCESSORIES

The information necessary for the installation are given together with the fittings. Anyway you can find here following a short description of the product.

Loading/Unloading Roller Tables – ON REQUEST - To install them correctly, it is necessary first of all to level and fix the machine. They are comprised of modular steel sheets, 2 meter long.

To connect it to the machine -LOADING SIDE- it is necessary to take away the first roller from the roller support of the machine, then connect directly the roller table by using the two holes – 8 and 9 / RI0442 - where the roller was earlier assembled

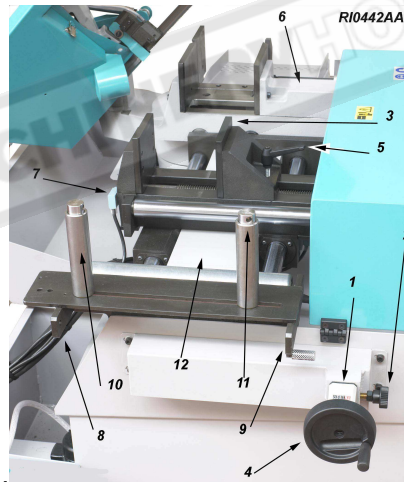

The unloading table – RIGHT SIDE – can be connected directly to the unloading slide thanks to the two lateral holes – 14/RI0464.

The alignment of the loading/unloading tables must begin with the one closer to the machine, taking as reference point the worktable and the back jaw. When cutting long bars, fix the table to the floor and make sure the coolant, which is carried by the bars, doesn't drop on the floor

INSTRUCTIONS FOR USE

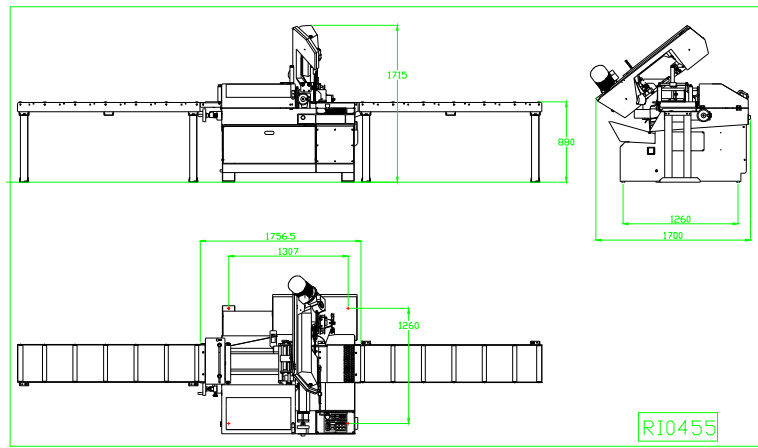

Vice pressure reducer - It allows to reduce the working pressure of the closing jaws compared to the general pressure of the system. It is a modular unit and it can be assembled also later between valve-holder base and the hydraulic valve (the one for the valve of the main vice is supplied as standard equipment; the one for the feeder vice is as Optional); it doesn't require any cable connections. By opening the left side front door you can adjust the pressure.

Hydraulic vertical vices for cutting bundles – As Connected to the standard vices, they allow to clamp and feed a bundle of bars; maximum breadth 300mm, minimum breadth 110mm, maximum height 120 mm. If you do not use this device, remove it thanks to the fast hydraulic connections; the one near to the blade has to be changed with the standard vertical vice, that is supplied as a remote part. Regulate the upper position of the saw-frame by the stroke-end screw (see above).

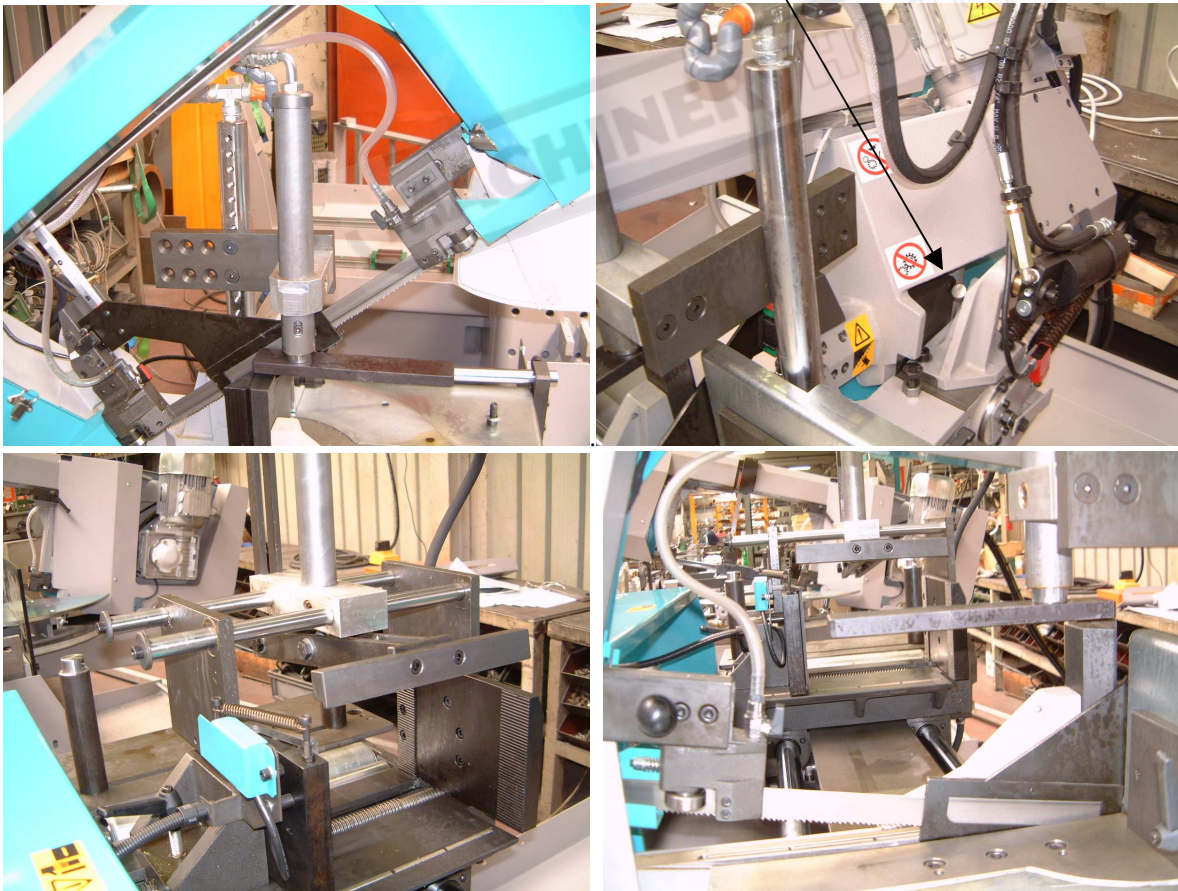

Minimal lubrication system – This device, applied to the saw, allows to eliminate almost completely the traditional coolant system, keeps the material much cleaner and avoids to waste cutting oil and water. It works only during the cut, it is depending from air supply.

INSTRUCTIONS FOR USE

It is comprised of a nozzle - 1/RI0463 - with 3 micro-holes, a tank with devices to adjust the quantity of oil and the air pressure. The switch of the electric system - 3/RI0462 - working with low tension 24V AC allows to turn it off at any moment and use the normal coolant system. Remove the nozzle 1/RI0463 to obtain the maximal cutting capacity.

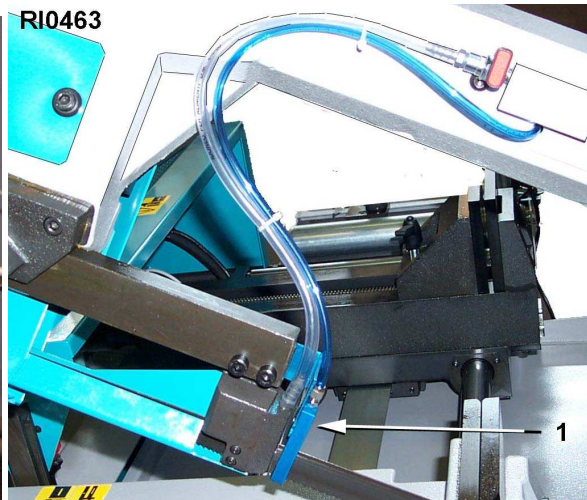
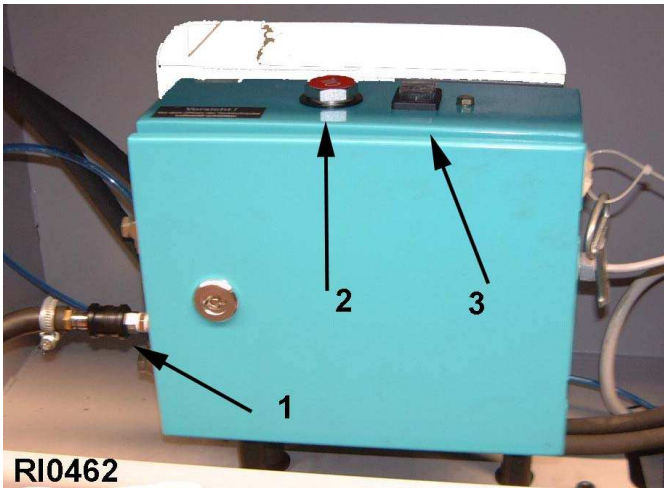

Voltage transformer - place it between the electric supply of the premises and the electric supply of the machine. It allows to work with a different voltage than the standard one (that is 400V / 50 Hz). Available voltages: 230V, 460V, 500V, 575V.

10 - BLADE CHOICE -

In this paragraph we recommend the type of blade according to the material to cut. To get the best performance from this machine it is necessary to understand how to use the tools and what you do not have to do with them. The blade for this bandsaw must have the following size (mm) :

maximum length = 3380 minimum length = 3360 height = 27 thickness = 0,9

The type of blade is also important, usually it's a bi-metal blade with different HARDNESS, named **M42** or **SVGLB** (for general purpose, tubes, profiles and solids, available in all pitch type), **M51** or **SHL** (preferred for big solids of hardening steel, INOX material too, available with 3/4 tooth pitch).

The durability of the teeth increases, and also the fragility, when going from the material M42 to M51.

To making a correct cut it's essential to choose the pitch (t) or the number of the teeth per inch (z). Usually the blade must have a pitch as follows :

- high pitch (small teeth), to cut thin materials, tubular and profiles.
- low pitch (big teeth), to cut solids or particular sections that require at times a big blade effort (for example, the central part of a U profile), or softer materials as aluminium, copper, soft bronze.

By choosing the right one you can avoid a lot of working errors, get a good cut and the necessary room for the chips. **If you cut more bars at the same time, you must consider them as a single bar and consider the total size.** The following table provide the information for a correct choice, **it can also be updated or modified by the user according to his personal experiences.**

Even if blades with constant pitch are available, most bandsaws allow to use blades with variable pitch - groups of teeth with different pitch between them - which reduce vibrations and noise, improving the quality of the cut and the performance.

SUGGESTED PITCH		SOLIDS Outside Diameter (mm)	BIG PROFILES Wall Thickness (mm)	PROFILES Wall Thickness (mm)	BUNDLE Length to Cut (mm)	REF.
VARIABLE	CONSTANT					
	14 M42	-	-	1,5 max	-	
10/14 M42	10 M42	-	-	1 a 2	-	
8/12 M42	8 M42	20 max	-	2 a 4	-	
6/10 M42	6 M42	40 max	-	4 a 8	-	

INSTRUCTIONS FOR USE

5/8 or 5/7 M42	5 M42	30 a 80	6 a 12	-	50 a 100	
4/6 M42	4 M42	40 a 90	10 a 20	-	70 a 120	
3 / 4 M42 o M51	3 M42 o M51	70 a 150	15 a 25	-	100 a 200	
2 / 3 M42 o M51	2 M42 o M51	120 a 230	Oltre 25		120 a 280	

These cutting recommendations are referred to a 100-mm diameter solid bar and a machine with standard features. For 2-speed machines we suggest the blade speed to use; if it is into bracket (), it is recommended to use a saw with ESC, which grants a continuous blade speed variation.

If the material size decreases, the figures shown can be increased, considering also the type of saw and its performance and/or some accessories - for example the ESC (Electronic Speed Control) – and vice versa.

MATERIAL GROUP	i.e. DIN denomination	DIN N°	Maximum BLADE SPEED m/min	Minimum BLADE SPEED m/min	MOTOR SPEED (1or2)	FEED FORCE	COOL ratio
1)STRUCTURAL STEEL	St37 St42	10037-10042	60	40	1.	BASSA	10%.
	St50 St60	10050-10060	50	35	1	BASSA	10%
HARDENING STEEL	C10 C15	10301 10401	45	35	1	BASSA	15%
	16MnCr5 20CrMo5	17131 17264	40	30	1	BAS/Med	10%
AUTOMATIC STEEL	9S20 10SPb28	10711	70	50	1 2	BASSA	15%
BEARING STEEL	100Cr6	13505	50	25	1	Med/ALT	5%
SPRING	65Si7	15028	40	30	1	Med/ALT	5%
2)TOOL STEEL	GG15 GG30	--	50	30	1	Med/BAS	dry
	ALLOYED	AL99.5 GaSi15Mg	--	300	50	2	Med/BAS
	CuSn6 CuSn6Zn	--	120 200	40 50	2 1 2	Med/ALT BASSA	2%
HIGH SPEED	C80W1	11525 11663	40	30	(1)	ALTA	5%
INOX STEEL	210Cr12 X155CrVMo	12080 12379	30	20	(1)	ALTA	dry
3)SPECIAL ALLOYS	X40CrMoV51	12344	30	20	(1)	ALTA	5%
	S-6-5-2-2	13243	30	20	(1)	ALTA	5%
	X5CrNi18 X10Cr1810	14305	30	20	(1)	ALTA	5%
TITANIUM	NiCr19NbMo	24668	20	15	--	ALTA	20%
	NiMo30	24810	20	15	--	ALTA	15%
1)STRUCTURAL STEEL	NiCr13Mo6Ti3	24662	20	15	--	ALTA	15%
	Ti1	37025	30	20	(1)	ALTA	10%
	G-TiAl6V4	37164	35	20	(1)	ALTA	10%

3. INSTRUCTIONS FOR USE AND WARNINGS

This bandsaw can carry out cutting cycles, at the end of which the material that has been cut has to be removed and if necessary the cutting conditions have to be changed = SEMIAUTOMATIC CYCLES

It can also perform autonomous cutting cycles, including the feeding of the bar until it has been completely cut = AUTOMATIC CYCLES

Thus the machine can be driven by the operator or carry out a cutting cycle automatically, which ends when the machine stops. The starting procedure has to be repeated to begin a new one.

INSTRUCTIONS FOR USE

i 11.1 - This machine is designed and manufactured so as to be safely used by the operator, provided that it is properly run. No protections will ever suffice if the operator does not work with caution, does not make sure that the machine is in top working conditions and does not follow the instructions below. Don't forget that this bandsaw is designed to CUT METALS with a proper tool, and that you are responsible for a SAFE and CORRECT use. You must :

1. check that the machine is properly installed and electric supply is suited.
2. be sure to learn all main features of the saw before running it.
3. do not expose yourself or any other people to any risk.
4. wear personal protective equipment
5. do not remove or modify the SAFETY DEVICES installed by the manufacturer, make sure that they are always in a good condition, too.
6. follow a regular maintenance schedule and check regularly the efficiency of the saw.
7. never use tools with unsuited characteristics
8. do not try to cut material with a size bigger than the cutting capacity of the machine
9. Keep the cutting area clear of tools or other loose objects.
10. do not run the saw unless all guards and protections are in place
11. NEVER WEAR loose clothing, long sleeves, large gloves, jewellery, or any other items that may get entrapped into the machine
12. Always disconnect the power supply when performing maintenance or making adjustments.
13. do not get close to the cutting area with your hands or any other part of your body when the saw is running
14. Clamp properly the material in the vice and never hold it with your hands
15. Support appropriately the bar from both sides to prevent it from falling

We recommend to install a roller table on the unloading side in case the cutting length of the bar is bigger than the distance between the blade and the right side of the basement

16. When cutting very short pieces, make sure they do not jam into the blade.
17. If the blade remains entangled with the material, stop the machine, open the vice and remove the material, then check the condition of the blade and the teeth: if they are damaged or broken, change the blade
18. Apply a constant pressure during the cut
19. Do not move the saw during the cut or cause instability
20. Wear personal safety equipment when running the machine

ALWAYS RUN THE SAW SAFELY, USING COMMON SENSE AND ALERTNESS

INSTRUCTIONS FOR USE

On some parts of the machine there are some stickers which warn about the safety measures that have to be taken by the operator who runs it. Their meaning (easy to understand) is indicated in the following chart

RI0151AA.TIF

SEGNALI DI AVVERTIMENTO E PERICOLO – SAFETY SIGNS	
SYMBOLS DE SÉCURITÉ – SICHERHEITSVORSCHRIFTEN	
	-Pericolo di taglio -Caution! Cutting area -Peligro de corte -Danger de coupe -Verletzungsgefahr
	-Usare guanti protettivi -Wear protective gloves -Usar guantes protectivos -Porter gants de travail -Arbeitshandschuhe tragen
	-Pericolo di schiacciamento -Danger of being crushed -Peligro de aplastarse -Danger d'écrasement -Quetschgefahr
	-Usare occhiali protettivi -Wear protective glasses -Usar gafas protectoras -Porter des lunettes de sécurité -Schutzbrille tragen
	-Pericolo di scivolamento -Caution! Slipping surface -Peligro de deslizarse -Danger de glissement -Rutschgefahr
	-Tensionamento nastro -Band tensioning -Tensionamiento cinta -Tension du ruban -Bandspannung
	-Pericolo: uscita aria/trucioli -Caution! Air/chip outlet -Peligro: escape de aire y virutas -Attention: Sortie d'air / des copeaux -Achtung! Luft und Späneaustritt
	-Bloccaggio/sbloccaggio lama -Blade locking/unlocking -Bloqueo/desbloqueo hoja -Blocage/débloccage de la lame -Sägeblatt klemmen/loesen
	-Pericolo scariche elettriche -Caution! Risk of electric shock -Peligro: corriente eléctrica -Attention: risque de décharge électrique -Achtung! Elektrische Spannung
	-Dispositivo di apertura sportello -Flap door opening device -Dispositivo de abrir la puerta -Dispositif d'ouverture de la porte -Öffnungsvorrichtung der Tuere
	-Non togliere protezioni durante funzionamento -Do not remove guards while machine is running -No quitar la protección durante el funcionamiento -Ne pas enlever les protections pendant le fonctionnement. -Während des Betriebes keine Schutzeinrichtung entfernen.
	-Non riempire oltre questo limite -Do not fill over this limit -No llenar más de este límite -Ne pas remplir en dessus de cette limite -Nicht ueberfullen
	-Non lubrificare/regular durante funzionamento -Do not lubricate/make adjustments while machine is running. -No lubrificar/regular durante el funcionamiento -Ne pas lubrifier/régler pendant le fonctionnement -Während des Betriebes keine Einstellung/Schmierung ausführen.
	-Zone sporgenti – Sagome pericolose -Protruding areas – Dangerous shapes -Zonas sobresalientes – Formas peligrosas -Zones en saillie – Formes dangereuses -Hervorstehende – Gefährliche Formen

RI0151A4



11.2 - OPERATOR'S SAFETY

This section illustrates the safety protections applied on the saw, according to the current legislation in the field of safety.

INSTRUCTIONS FOR USE

**11.2.1. ELECTRIC EQUIPMENT – Norm EN 60204-01**

- . Electric board closed with screws - general switch
- . Marking of the electric components used, according to the indications on the electric scheme
- . Control circuit with 24V tension – Control transformer with fuses on input and output
- . Earthing of all electric parts with a dedicated GREEN/YELLOW wire, connected with a TN system to the supply cable. A supplementary earthing point – indicated with PE – can be located on the metallic structure of the machine.
- . Minimum tension coil that prevents accidental restarting after a lack of tension.
- . Protection from overloads and high temperature thanks to bimetal thermo-protectors placed directly in the blade motor
- . Emergency button for interrupting immediately all the movements of the machine. In order to restore all the functions, rotate the button half a turn.
- . Sensor of the blade tension: in case the blade breaks or the tension strength diminishes, the machine stops immediately
- . Sensor of the closing of the blade protection: if it opens during an automatic cycle, the machine stops.
- . Sensor for opening/closing of the vices: they check that both vices have been properly positioned
- . The stops caused by one of the aforementioned devices needs a complete restoring of the working cycle

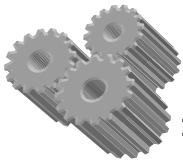
**11.2.2 – PROTECTION AGAINST ACCIDENTAL CONTACTS**

- . Complete metallic protection of the blade and the pulleys, the blade-cleaning brush and the back blade-driving pads
- . Forward metallic moving guard, fixed to the forward blade-driving pad. It assures the coverage of the blade in every position, except for the stretch of blade which makes the cut. Joint to the blade-driving pad, it can be opened only after the opening of the main protection
- . Positioning of the saw blade thanks to the buttons located on the control board, in order to limit the width of the danger area to the stretch of blade strictly necessary for the cut.
- . During the cycle an automatic approaching device stops the saw blade near the material, in order to start the cut.
- . Clamping vice with a maximum stroke of 7 mm, according to the norms on automatic closing
- . Guard extended to both sides which retains the coolant used during the cut, preventing it from spilling on the floor
- . Parts of the machine with suitably chamfered or rounded angles

**11.2.3. LIGHTING OF THE WORKING AREA**

An inadequate lighting can cause accidents to the operator, who consequently needs a suited lighting in the working area. In case of a lack of precise indications (for example, norm ISO 8995) for special areas, we advise to supply a lighting equal to 750 LUX.

INSTRUCTIONS FOR USE

MACHINE DESCRIPTION, E.C. SAFETY NORMS

This is a semiautomatic/automatic electronic, hydraulic bandsaw equipped with position sensor that allows a fast drop by the sawframe. Suitable for cutting metal profiles and solids from 0° to 60° left.



It is not suitable to cut wood and similar materials (see D.M. 89/392, enclosure I, paragraph 2.3).

The automatic cycle is comprised of: clamping the material, feeding and cutting, sawframe return and unclamping of the material. The operator has to adjust the cutting parameters, the sawframe rotation for miter cutting and to load a new bar at the end of each cutting cycle. The feeder strokes, the cutting lengths and the number of cuts are programmed by means of the keyboard.

The Safety Norms and the Directives applied are mentioned in the enclosed Declaration of Conformity.

From the working position in front of the saw - WORKING AREA - the operator can activate all drivers, check the correct working of the saw and avoid dangerous areas.

In the following paragraphs you will find all information for using the machine in the best way and for a very long time.

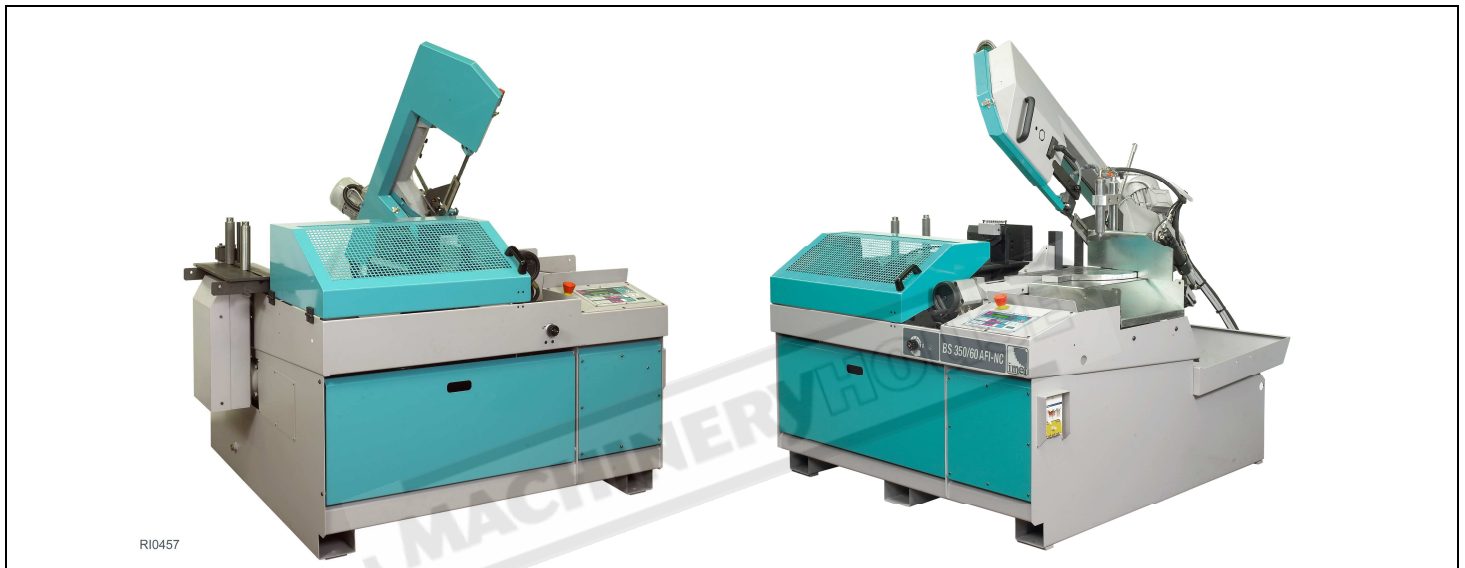

13 - MACHINE SETTING FOR STARTING

Verify that machine does not have damages or faults and check the standard equipment which includes tools, fittings to perform some adjustments, user's book.

In case the machine is supplied with additional equipment, make sure it is suited to the machine. Point out promptly possible damages or faults to the reseller or to the service staff before running the saw.

Remove the locking bracket between the sawframe and the basement and put it in the left side of the floor stand - 11/R10464 - Remove the protective elements placed on the machine in order to safeguard it when shipping it and handling it, by using proper objects or paper. Check also that there is no rust on the metallic parts.

In case compressed air jet is used, always wear proper eye protection.

Take out the chip collector tank located in the back - 5/R10464 - by unhooking it from the guides, then remove possible objects inside which can hinder the coolant flow.

The parts in motion (band guides, trolleys, hinges, bearings, and so on) are already lubricated, the gear box contains the precise quantity of oil needed to work. The hydraulic system is ready to start.

INSTRUCTIONS FOR USE

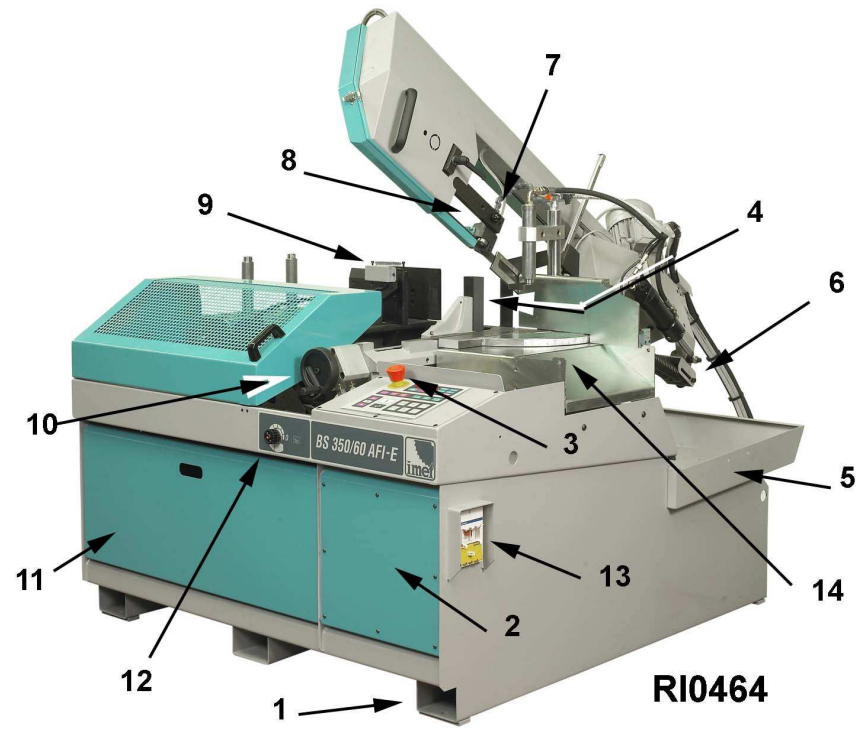

13.1 - COOLANT

Prepare the coolant by mixing cutting oil and water (the tank capacity is about 60 liters) in proportion 1/10, 1/15 or according to the instructions provided by the supplier. Pour in the coolant in the tank – accessible in the back side of the floor stand - or directly on the work table. In this case make sure that the chip tank is correctly placed.

13.2 - ELECTRICAL CONNECTION

Verify that voltage and power frequency are compatible with the figures shown in the technical data plate (placed on the right side of the floor stand); a difference over 10% causes some working troubles.

This operation must be performed by authorized operators (i.e. by an electrician). The phasing performed by the manufacturer allows to get a right rotation of all motors by connecting the wires in the following order L1=R, L2=S, L3=T, N=neutral wire;

Anyhow check what follows (with the blade protection closed):

- if the Emergency button is pressed, turn it 1/4 of a round in the direction indicated by an arrow
- turn on the main switch, located on right side of the floor stand: a few lights turn on, on the display some numbers related to the programming appear and the motor of the hydraulic unit turns on.
- verify that the manometer of the hydraulic unit indicates a pressure of at least 18/20 Bar, and push the buttons - 3/RI0408 - or - 13/RI0408 - to move the sawframe up and down.

If this doesn't happen within 5/10 seconds, turn off the saw by means of the main switch, disconnect the feeding plug and exchange the connection of two wires, with exception of the green/yellow earthing wire and NEUTRAL wire. Then start again from point a)

- verify that the coolant flows correctly from the tank to the cutting area (when the taps are opened and the pump is active).
- stop the machine by means of the main switch

In case an external voltage transformer is supplied, be sure to place it in a safe position, far from the material loading/unloading areas.

14 - BLADE TENSION

 The machine is equipped with a tensioned blade (if it is not tensioned the motor will not start until the blade is correctly tensioned). If it is not so, before running the saw, please verify what follows:

Open the blade guard and check that the blade is on the pulleys – 2 /RI0456 - and correctly placed into the guides – 3/RI0456.

If necessary, loosen a little bit the screw of the blade-tensioning device to better position the blade, then close the blade guard and make sure that the stroke-end key is placed into its slot.

INSTRUCTIONS FOR USE

Press the main switch and look at what appears on the display: a small BLACK point means that the blade has not been tensioned enough: tighten the frontal screw until a small circle appears; then tighten 1/4 of a round more in order to prevent future loosening.

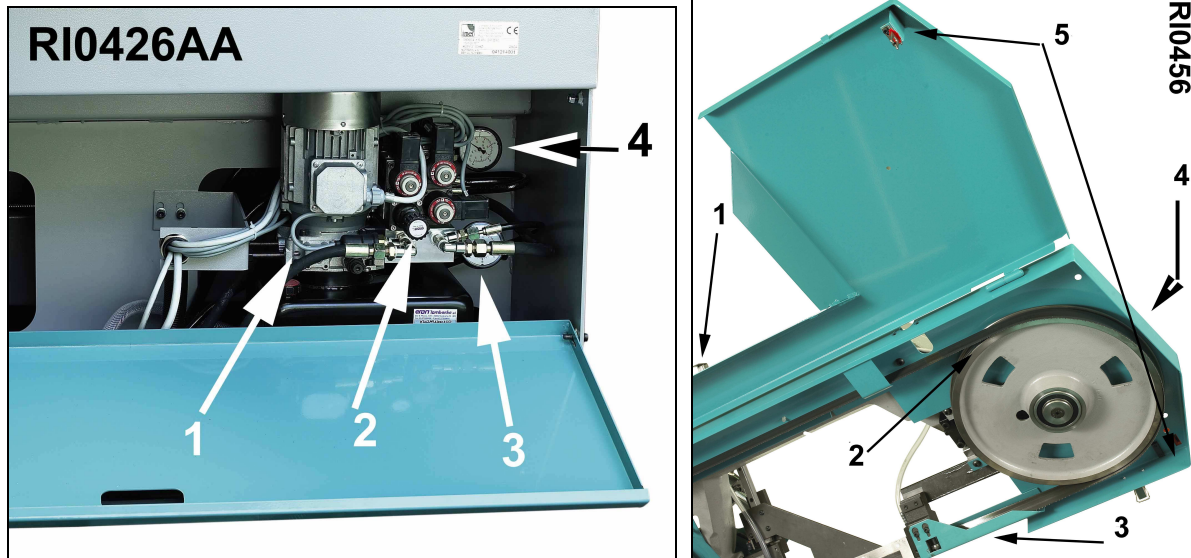

This procedure has to be followed also when changing the blade. In this case a careful cleaning of all contact points with the blade will be necessary.

15 - DRIVERS DESCRIPTION

1- main switch with thermic and magnetic protection of the whole equipment, complete with a device to shield from voltage drops. This switch selects the external power supply.

2- emergency: it stops all electric devices when activated. In order to restore it, rotate the button - 3/RI0439 - by 1/4 of a round.

Other drivers are placed in easily accessible areas:

3- hydraulic device to adjust the cutting speed - 12/RI0464

4- device to adjust the general pressure - 1/RI0426

5- manual opening/closing of the main vice - 10/RI0464

6- locking/unlocking of the worktable rotation to perform angle cuts, on the right side of the worktable

7- taps of the coolant system - 27/RI0464

8- locking/unlocking of the shaft carrying the forward mobile blade guide - 8/RI0464

9- locking of the feeder vice - pos. 4/RI0442.

15.1 START OF THE PROGRAMMABLE CONTROLLER"

Each time the machine is turned on, on the display the code of the software release is shown (example: "SAW2 IMET 1.4"). Then the bandsaw performs the calibration of the length by moving slowly the feeder towards the cutting area, in order to set the RESET point.

To continue, the button **10 has to be pushed, so that the oil pump turns on. If other buttons are pushed, the display shows the following error message: **HYDRAULICS OFF**.**

If no other button is pushed within 5 minutes, the electronic control deactivates the oil pump. To activate it again, push again 10.

After this step the machine is ready to work in automatic cycle.

Sometimes, after turning on the machine or because of anomalies (for example, blade not tensioned), error codes appear (such as **BLADE NOT TENSIONED/BROKEN BAND**).

In cases like this, the corresponding button has to be pushed – i.e. 32 **O** or 29 **ENTER** and the cause of the problem has to be eliminated (for example, to give the correct tension to the blade).

INSTRUCTIONS FOR USE

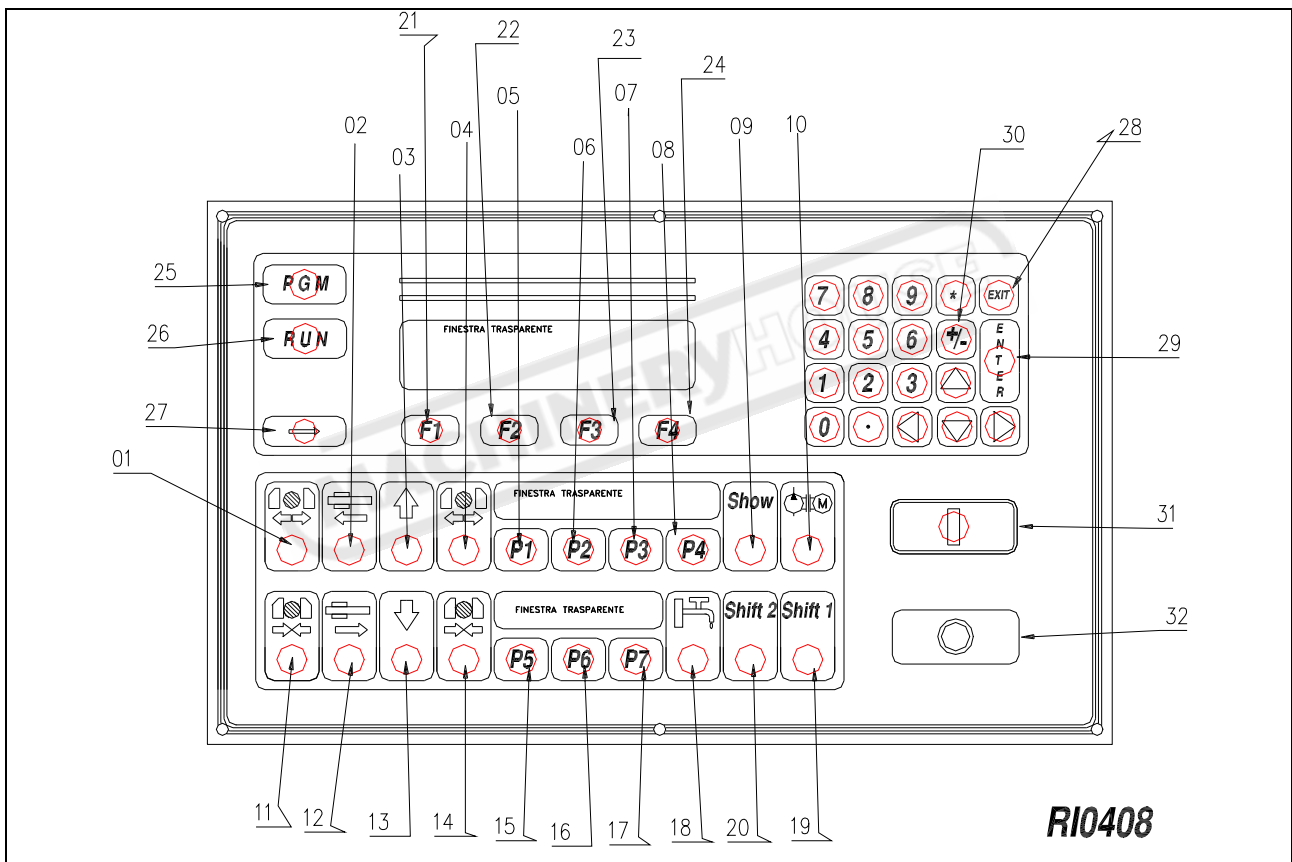
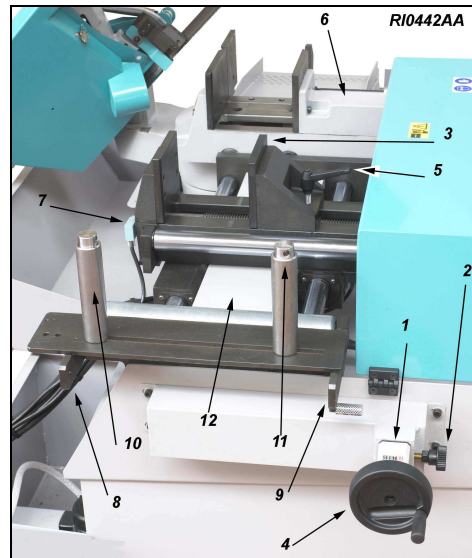
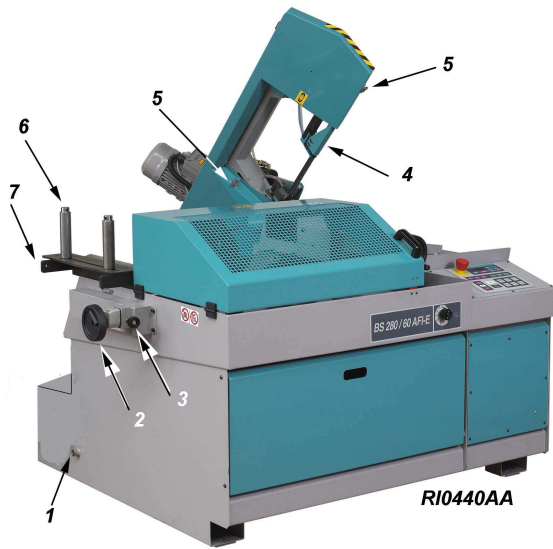

15.2 – KEYBOARD / Description of the buttons and their use – drawing RI0408

All the actions performed by the bandsaw can be programmed by means of the keyboard, including the positioning of the cutting unit:

01 = Opening of the feeder vice
11 = Closing of the feeder vice

02 = Movement of the feeder to the right, towards the cutting area
12 = Movement of the feeder to the left

03 = Sawframe up
13 = Sawframe down

04 = opening of the main vice
14 = Closing of the main vice

INSTRUCTIONS FOR USE

06 = machine stop and program end

05 –
15 – NOT USED
16 –
17 –

07 = Increases the blade speed (indicated with a number between 20 and 100; on some versions it can be between 2.0 and 10.0)
08 = Reduces the blade speed
Such speed can be modified both when the blade is running and when it's stopped. Big variations during the cut have however to be avoided, since this could lead to a break of the teeth or to the blade remaining stuck into the material.

09 = = display of the parameters
POSITION-SAWFRAME: =sawframe above the position sensor; =sawframe under the position sensor; =sawframe under
BLADE SPEED = from 18 to 100 m/min
COOLANT STATUS : =always on; =off; =on only during the cycle
WORKING STATUS : =cycle off; =cycle steeps

10 = Turns on/off the motor of the hydraulic unit (which automatically turns off after 10 minutes of inactivity)

18 = Selection of the coolant flow: , , on only during the working cycle

19 = When the blade is in the cut-end point, by pushing this button along with the **End-cut position** is memorized (ON OLDER VERSIONS NOT PROVIDED WITH POSITION SENSOR)
When the blade is in the start-cut point (8/10 mm over the workpiece), by pushing this button together with the **Start-cut position** is memorized (ON OLDER VERSIONS NOT PROVIDED WITH POSITION SENSOR)

20 = Shift 2 – By pushing it along with 13, the sawframe comes down quickly.

21-22-23-24= to choose/activate the options which appear on the display

The buttons 25 and 26 are used to recall the cutting programs which have been stored(max10, each with 10 different cutting lengths and number of cuts)

27 = when pushing it along with the buttons F1-F2-F3-F4, it allows to use the options F5-F6-F7-F8

On the top right you find the numeric buttons, the arrows to move the cursor on the display, the confirmation button 29 , cancel/abandon 28 and positive/negative change 30 .
Die Taste "Sternchen * " erlaubt, die Stückanzahl am Ende der Arbeit auf Null einzustellen.

15.3 – PROGRAMMATION OF THE CUTTING AREA

Thanks to the new device – position sensor – to detect automatically the start-cut point, the user doesn't have to set up the start-cut and end-cut points. The sawframe drops always quickly until the position sensor - 1/R10465 – touches the material, then the sawframe speed is automatically reduced to the one selected by the user. The end-cut position can be adjusted by means of the small rod – 3/R10465 – of the end-stroke.

INSTRUCTIONS FOR USE

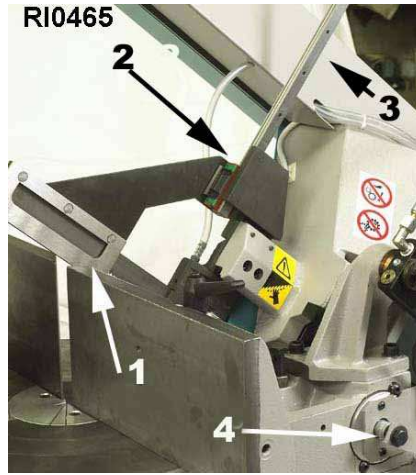

The movement of the sawframe is shown by four symbols:

- 1- ***HIGHEST SAWFRAME POSITION* SET BY THE MANUFACTURER**, corresponds to the highest point the sawframe can reach, indicated on the left of the display with the symbol **A**
- 2- ***START OF THE CUT automatic thanks to the position sensor**. It is indicated on the display with **a**
- 3- ***END OF THE CUT chosen by the user, by moving up or down the small rod which activates the correspondent end-stroke**. It is indicated with **b**
- 4- ***LOWEST SAWFRAME POSITION* SET BY THE MANUFACTURER**, corresponds to the lowest point the sawframe can reach. It is shown with **B**

As the sawframe moves up/down, on the display the symbol **T** appears if the blade is over the cut-start point, the symbol **t** if it is instead between the cut-start and cut-end points.

Usually the positions 1 and 4 – set by the manufacturer – correspond to 100% of the maximum cutting capacity allowed. In case of variations please contact the Technical Service.

15.4 - INFORMATION TO THE USER/1 = Working parameters

The button **09** allows to see a series of data relating to the working of the machine:

NUMBER OF CUTS TO MAKE = **Q**. Progressive number from 1 to 9999

BLADE SPEED = **V**. Progressive number from 20 (lowest blade speed) to 100 (highest blade speed). It can also be displayed from 2.0 to 10.0

SAWFRAME POSITION = according to the sawframe position, the symbols **A** - **T** - **a** - **t** - **B** appear with a numeric value nearby.

INFORMATION TO THE USER /2 = **Error Chart (AUTODIAGNOSTIC)**

This electronic driver allows to single out the origins of possible working anomalies. The most common are visualized on the screen:

Emergency Chart SAW2

Code	Message on Display SAW2	Notes
E01	Emergency	Emergency button pushed
E02	Blade guard open	It has been opened
E03	Feeder Guard	It has been opened
E04	Broken blade	
E05	Vice open	
E06	Feeder vice open	
E07	Feeder forward	Feeder all the way forward
E08	Not used	
E09	Not used	
E10	Feeder backward	Feeder all the way back
E11	Inverter Fault	Blade motor Inverter Error
E12	Feeder Inverter Fault	Feeder Motor Inverter Error
E13	Blade motor	Blade motor thermic overload
E22	Cut Timer	Cut Timeout – too long cutting time

INSTRUCTIONS FOR USE

E23	Position Error	Feeder positioning error following GOTO
E25	GOTO Position error	GOTO position required is beyond maximum stroke

Emergency Chart BRA

--	END OF THE BAR	The material has run out
W01	Emergency	The emergency button has been pushed
E08	Blade guard open	The blade guard has been opened
E23	Feeder guard	The feeder guard has been opened
E07	Broken blade	The blade is broken
W09	Hydraulic unit off	The hydraulic unit engine is off
W33	Vice and pliers closed	Both the vices are closed
E76	FC SW forward	The feeder is completely forward
W29	FC forward	The feeder is nearly completely forward
W30	FC backward	The feeder is nearly completely backward
E77	FC SW backward	The feeder is completely backward
E03	Thermal sensor group B	Thermal interference of the blade engine or blocked INVERTER
E02	Thermal sensor group A	Blocked inverter of the feeder engine
W16	Sawframe under the position sensor	The blade is ready to begin the cutting
E87	Blade time out	Timeout has occurred : the cutting has been lasting for too much time
E81	Position error	Error in the position of the feeder
E77	GOTO position error	GOTO position required is beyond maximum stroke

Eliminate the origin of the problem and push the button indicated on the display to cancel the error message

15.5 – PREPARATION FOR THE SEMIAUTOMATIC CYCLE

The blade supplied with the bandsaw allows to cut different material sizes, thanks to the variable tooth-step (small teeth alternating with bigger ones), but then the most suited blade has to be chosen in order to get the best performance.

Therefore we recommend to read the related paragraph “BLADE CHOICE”.

Turn on the machine by means of the main switch and restore the emergency in case it has been activated; after turning on, the machine performs automatically the calibration of the feeder, moving it left.

Put the material on the worktable, leaving about 2-3 mm room between the material and the jaws, necessary for the automatic closing of the vice. The bar has to be positioned slightly before the cutting line. Push the button - 14/RI0408 - to close the vice.

 Be sure that the material is effectively clamped by the jaws and that the closing pressure is suited, that is, it doesn't cause any deformation to it. The roller 11/RI0408 has to be drawn close to the material to allow an easier feeding.

During the semiautomatic cycle the feeder guard can either be closed or opened, as the end-stroke which checks it is not working.

Lock the screw -2/RI0468- on the vice scrow to avoid it from opening during the work. Position the shaft that carries the forward blade guide – Pos. 8/RI0464 – so that there is no danger of hitting the material or the jaws when the sawframe moves downward.

15.6 – SEMIAUTOMATIC CYCLE

Place the bar just beyond the cutting line and clamp it, select the blade speed, the coolant flow (continuous, only during the working cycle, off), then push the white button START  - 31/RI0408., Adjust the coolant flow on the blade by means of the two taps, and, after the quick motion of the sawframe, begin the cut and possibly adjust the blade speed – 12/RI0439. At the end of the cut the sawframe returns back and stops.

This cycle has to be used for trim cuts and for single cuts.

INSTRUCTIONS FOR USE

By using the function GTO it is possible to move the bar by a determined measure and then to cut it: press the button under GTO, digit the measure in mm and press the white button—31/RI0408- I .
The feeder moves the bar by the chosen measure and it is possible to cut the bar semi-automatically.

15.7 - ESC Electronic Speed Control

The Inverter allows to change the blade speed continuously, optimising the use of the blade according to the type of material.

With the motor running, increase or decrease the speed simply by pushing – 7/RI0408 V+ - or – 8/RI0408 V- until the desired blade speed has been reached.

In order to avoid breaking the blade or causing it to remain stuck into the material, it is recommended **not to vary the speed too much during the cut.**

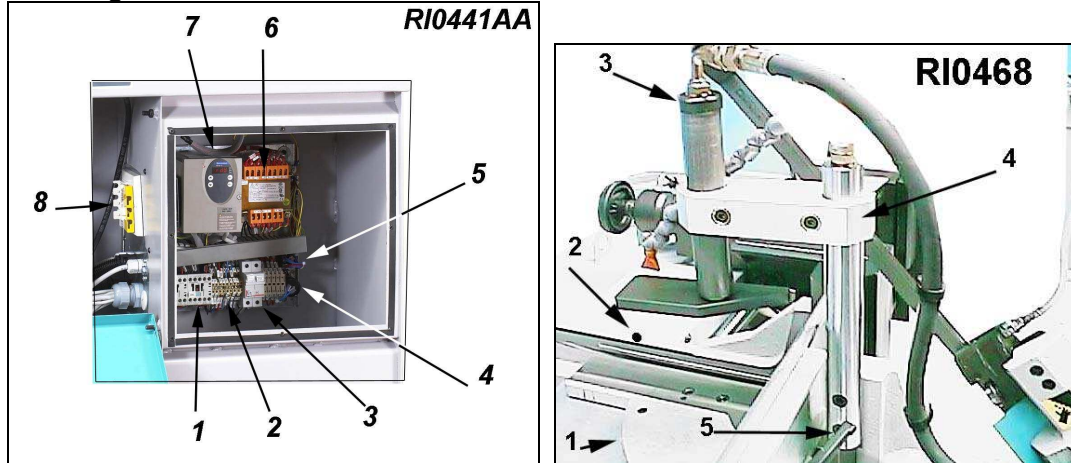

15.8 – STOP / EMERGENCY STOP

The working cycle can be stopped at any moment:

- by pushing the black button STOP O , the machine stops immediately, but all the other functions remain active, such as, for example, changing the working cycle or the blade speed.
- with the emergency button the stop is also immediate, and no other function of the machine is active. The emergency has to be restored before being able to operate again.
- by means of the main switch the power is turned off.
- by opening the blade guard, the related end-stroke interrupts the drivers circuit, causing all the motions to stop. Also the stroke-end of the feeder guard interrupts the circuit when it is opened in automatic cycle.
- in case of a power drop, the switch moves to the 0 Position and has to be restored in order to run the machine again

15.9 – HEAD ROTATION FOR ANGLE CUTS

In order to perform cuts between 0° and 60° in auto matic cycle unlock the lever –5/RI0468-placed on the side of the worktable, manually rotate the sawframe until reaching the required angle on the graduated scale –1/RI0468-, then lock again the lever. Easy return stop at 0, 45, and 60° .

When changing angles there shouldn't be any materials clamped by the vice and/or on the worktable.

15.10 - AUTOMATIC CYCLE – refer to drawing RI0408

To create cutting programs is necessary in order to perform automatic cutting cycles.

At the first use we advise to make the zero setting of the feeder position, repeating it if the feeder is moved with the machine switched off:

While the vices are opens, without material, saw frame up, press F1 -21/RI0408- then still F1 (over appears AZZ), to the demand for PASSWORD digit 963852 and press ENTER -29/RI0408. Then press F1 more and finally the white button START I

To check the machine functions, you can use the program already memorized or create a new one, by completing the following steps:

- push the button 25 PGM , then the button 21 F1 below the word NEW which appears on the display (the other words have this meaning: EDIT= show programs stored, DEL= cancel program, CA=cancel only one line of the program)
- dial in the data on the cuts to make: to the right of the symbol L the cutting length, then push 29 ENTER to confirm. Dial in to the right of the symbol Q the number of pieces to cut and confirm with 29 ENTER
- push 28 Exit if there is no other data to dial in or instead push ENTER again to insert other cutting lengths and related number of cuts – for a maximum of 10 different types.
- place the material on the worktable, just before the cutting line

INSTRUCTIONS FOR USE

5) push **RUN** (on the display the selected program appears, if there are more than one, scroll them by the red arrows), then the button located below the word RUN and later the white button **START** **I** ; the display shows TRIM CUT YES NO , you press the related button: the feeder positions itself, the two vices close and the working cycle starts. The electronic control verifies constantly the correct work of the machine, and in case of anomalies the display identifies the error and the working cycle stops. The reason of the problem has to be eliminated to continue

DURING THE AUTOMATIC CYCLE THE PRESENCE OF THE USER IS NOT NECESSARY OR CAN BE LIMITED TO SUPERVISING THE PROCESS.

At the end of the working cycle the machine stops waiting for the zero setting of the piece counter or the start of a new cycle, without exiting the automatic working modality. The display shows END PROGRAM.

At the end of each bar the bandsaw stops, waiting for a new bar to be loaded. **Take away what is left of the previous bar and place the new one just beyond the cutting line, start the program again and make the trim cut – which is not counted**

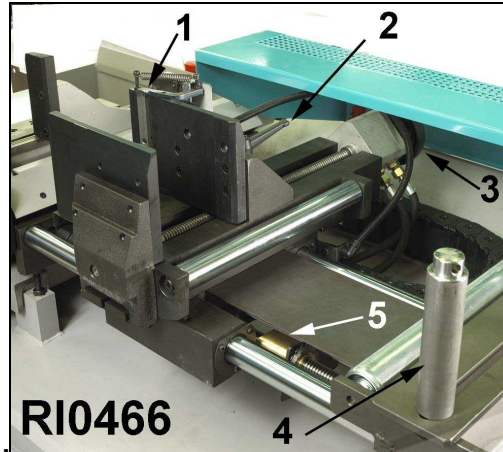

It is possible to clean the amount of pieces indicates in a program, therefore to repeat of the execution: recall the program to repeat (RUN/push-button under RUN/to select the program to repeat using the arrows) then press key ASTERISK up to right. The amounts of pieces come cancelled and pressing START **I the same program is repeated.**

15.11 - PROTECTION AGAINST OVERLOADS

The motor is protected against excessive heating thanks to bimetallic thermo-protectors (placed directly in the coil) which interrupt the drivers circuit. **If this happens, the corresponding error message appears on the display.**

The normal working can be restored – after the temperature has dropped below the required level - only by starting again the cycle.

In the meantime look for and eliminate the origins of the excessive heating, such as, for example, high cutting speed, no oil in the gearbox, short circuits, blade stuck into the material, and so on.

If such a problem happens often, look at what kind of error message appears on the Inverter display – 7/RI0441 – and communicate it to the Technical Service.



16 - ADJUSTMENTS

BLADE - Carbide metal pad adjustment according to blade thickness - drawing RI0181

This adjustment must be done when you have a blade with thickness other than 0.9 mm or in case the hard metal pads are worn out. The easiest test is the following: put a blade in the guides and move it back and forth to evaluate the mechanical play. Depending on the result, proceed as follows: loosen slightly one screw – 1/RI0181 – to make more room for the blade (or tighten it to get the pads closer). put the blade inside a guide and, while pressing manually the two parts one against each other, tighten strongly the two aforementioned screws.

Check that the mechanical play is not excessive (Max. 0.02 or 0.03 mm) and make sure that both screws – 2/RI0181 - are properly tightened.

The lateral pads are mechanically fixed and each can be replaced without removing the whole blade guide, just by loosening completely the two screws – 2/RI0181. By removing both lateral pads, the special upper pad which is in contact with the blade can be removed

INSTRUCTIONS FOR USE

BLADE - Check the perpendicularity between blade and worktable: this is very important and, along with the blade tension, it assures straight cuts. Check it the following way: with the sawframe up and at 0° and the vice completely open, put a square at 90° on the worktable (close to the supporting jaws) and very close to the blade.

While keeping the square still, lower the sawframe until reaching the end-cut point and evaluate if the blade gets closer to it or farther. Lift the sawframe, move the square towards the operator so that the blade is close to the higher extremity of the square, then lower the sawframe again until reaching the end-cut point while always keeping the square still.

Usually this test allows to single out geometrical errors, but it is even more important in order to ensure that, in case of not perfectly perpendicular cuts, the reason is not linked with factors external to the machine (for example, blade in a bad condition, wrong tension, wrong tooth pitch, excessive pressure during the cut).

SPRINGS – It may be necessary to modify the tension of the return springs – 6/RI0464 – located in the back of the sawframe. Loosen the fixing screws of the floating plate and, by turning the back screw, position them in their slots. Tighten strongly the screws.

It is recommended to carry out this procedure while the sawframe is all the way up. If you have problems doing it, you can lower the back stop screw before tensioning the spring, and then put it back in the original position.

CUTTING SPEED - Rotate the handle – 12/RI0464 – from 0 to the maximum level to increase the down-feed speed: any variations should be made considering the type, shape and size of the material, the blade speed and life, the coolant, and so on.

VICE PRESSURE - Additional valves to reduce the vices clamping pressure can be assembled in case the material could deform. Since they are modular, they do not require any adjustments and can be assembled at any time, one below each vice.

FEEDER - The feeding speed when forwarding the material (and during the return) is linked with the inverter functions. If the feeding times are much different than normally (max. 14 seconds for a complete stroke forward and backward, each one of 500mm), check if there are mechanical interferences or rollers alignment problems.

CONTROLS PARAMETERS – by using the proper PASSWORD it is possible to set / change some of values of machine functioning. Ask to the Customer Service . Some features of the CNC can be changed according to the kind of job the machine has to carry out. Here are the standard data, useful to execute a resetting.

AUTOMATIC PARAMETERS

P001	mm	505,0
P002	mm	1,00
P003	mm	1,3
P004		3
P005		0
P006		-
P007		H12
P008		1
P009	mm	325
P010		-
P011	m	30
P012		0
P013		0
P014		-
P019		0
P020		0
P021		1
P022		0
P023		0
P024		0
P025		2
P026		1
P027		0

OTHER PARAMETERS

P7	CUTTINGS MADE	...
P8	TOTAL TIME CUTTINGS	...

INSTRUCTIONS FOR USE

P9	BLADE LIFE TIME		
P13	CONFIGURATION		(ex: BS3B02)
P14	MODE OF UNIT	0 (for mm)	1 (for inches)

AXLE1/FEED

P08	POSITION TOLERANCE	mm	0,20
-----	--------------------	----	------

There is also a function for the remote control of the input/output in the PLC: to get there from the start page digit F1 + F2 + 123456 (the password) + ENTER.

You will see two series of points and lines with indicated **i=inputs and o=outputs**. With them it is possible to check that the signal gets from the device (a limit switch, a solenoid valve, etc.) to the PLC.

In other words it is possible to check that there is no signal interruption along the cables and that the tested device works properly. For a correct use consult the assistance service.

17 – MAINTENANCE – for the user

Regularly carry out maintenance operations as described below to maintain unchanged the machine safety devices and technical features of the saw.

17.1 PERIODICAL MAINTENANCE

To be carried out **DAILY** or more often if the machine is doing a heavy job. Remove the chips from the machine conveying the smallest ones into the chip tray – 5/RI0464. Remove and empty the chip tray; add coolant if necessary; check the wear of the saw blade and replace it if necessary; check the blade brush and the transmission ring – 1/RI0182 - and possibly adjust or replace it.

Clean the machine **WEEKLY**, lubricate all joints and surfaces in contact with oil or grease. Make sure that there is oil in the hydraulic unit tank while the saw is off: remove the plug and check that the oil reaches up to 3 cm from the edge. Check the oil level in the gearbox: with the sawframe all the way down, it must reach the extremity of the proper stick – 5/RI0174.

Replace the coolant **MONTHLY** and clean the tank. Ensure that all screws and bolts since they may have loosened. Make sure that stroke-ends and switches work properly; check the leads, tubes and hydro-pneumatic connections; make sure that seldom-used devices work properly. Check the two blade guides and the hard metal pads inside, adjust and possibly replace them (drawing RI0372).

Once a **YEAR** - or after 2000 working hours - replace the oil in the gearbox, as shown in the chapter MACHINE RUN IN.

17.2 - BLADE REPLACEMENT – drawing RI0177

- This is the most frequent maintenance operation, due to the natural deterioration of the blade; it is essential to replace it correctly and safely. With the sawframe up and at 0°, power off: open the blade guard - pos. 1 - and lift it, loosen the blade tension device by means of the front screw. Remove first the blade from the pulleys - pos. 2/3 - then from the blade guides – pos. 4/5 - using protective gloves while carrying out these operations.

Make sure that there are no chips or dirt on the pulleys, and following the cutting direction, shown also by an arrow, put the new blade in the guides **without removing the plastic protection**, and then on the pulleys. The upper supports prevent the blade from falling. Tighten the tension-adjusting screw and make sure the blade is correctly placed on the pulleys. **Remove the plastic protection**, then assemble the blade guard and the front mobile protections.

Press the main switch and look at what appears on the display: a small **BLACK** point means that the blade has not been tensioned enough: tighten **the frontal screw until the small circle appears; then tighten 1/4 of a round more in order to prevent future loosening.**

INSTRUCTIONS FOR USE

RI0181AA.TIF

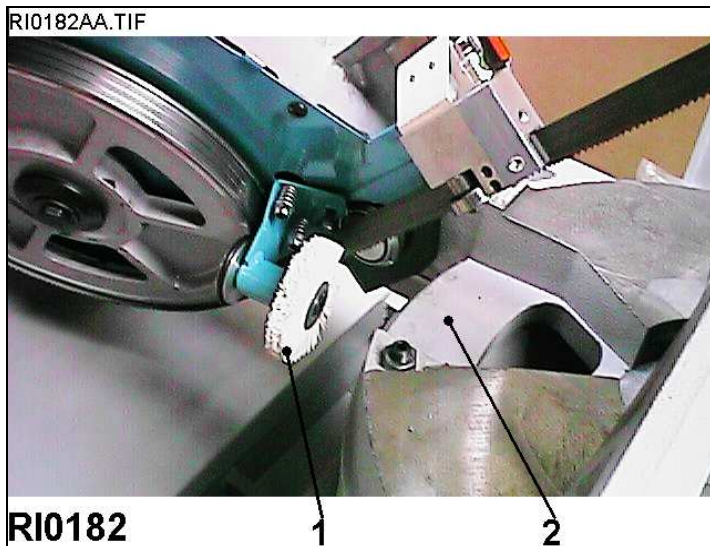
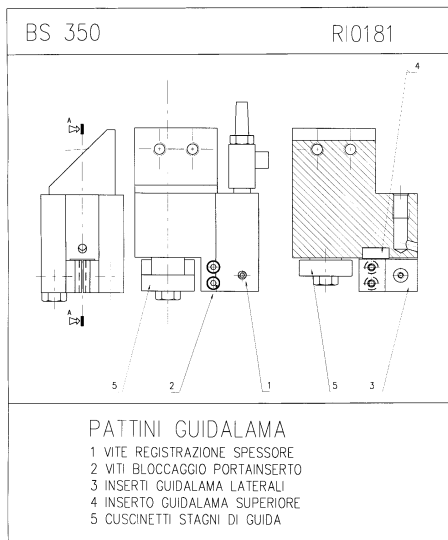

18 – BLADE RUN-IN

To grant an efficient performance and a longer blade life, a good run-in of the blade is crucial each time you use a new blade.

During the first cuts of a blade, we recommend to reduce the penetration speed up to half the normal value - about 40 cm²/min - and keep a constant blade speed. Only after cutting 250/350 cm² of material the penetration speed can be increased till reaching the normal value.

The working conditions can also be evaluated by observing the chips produced during the cutting; you can find 3 kinds of chips:

THIN OR POWDERED CHIPS indicate poor advancing pressure and/or low speed; teeth too little.

BIG CHIPS (MAYBE BLUE / BROWN) indicate overload on the blade, poor lubricating.

SPIRAL AND RIGHT DEVELOPED CHIPS indicate the ideal cutting conditions.

For a correct use, see the paragraph BLADE CHOICE

19 - MACHINE RUN-IN

The maintenance required by this machine is essential to guarantee the continuous correct working over the course of time and keep the saw in an efficient condition. When you start to use the machine you must do some extra operations to allow all parts of the machine to settle down to the working conditions.

Please check frequently the working of the machine and avoid to force it to make too many cuts. For a time of 80/100 working hours check the oil level in the gearbox: while the saw is running, the oil must fill about half of the oil window with the sawframe all the way up.

After this time, unload the oil completely by removing the lower plug, shown by a sticker. Put in the plug again and introduce gasoline for internal cleaning. Run the motor a few seconds, unload the cleaning liquid and then pour in new oil – about 1.5 liters – to restore the normal level.

Check also the oil level in the hydraulic unit tank, which must be about 3 cm below the plug edge.

Note: The presence of bronze and/or iron particles in the oil is normal. The heating of the mechanical parts (and of the hydraulic parts on semiautomatic and automatic machines) is normal during the usual work and anyway it does not exceed the conventional thermic limits.

Please see the OIL AND LUBRICANTS TABLE in order to choose the most suitable one and to compare the different types

TABLE in order to choose the most suitable one and to compare the different types (see drawing RI0108).

20 - DRAINING OF USED / PRODUCED SUBSTANCES



Please remember to follow the current Law Norms concerning the draining of:

- materials used by the machine (for example hydraulic circuit oil, reduction gear oil, oil for installations of lubrication and so on);
- working scrap materials or materials not usable anymore (for example ferrous and not ferrous chips, tools like:

INSTRUCTIONS FOR USE

- saw bands and blades and so on);
- substances used for cleaning and maintenance;
- materials used in some periods of machine life only (for example for packing, transit and so on).

Do not throw the packing away as it might be used in case you should ship the machine or return it to the distributor or to the service staff - when the machine is still under guarantee.



21 – TROUBLE-SHOOTING

The solution of most inconveniencies that could happen during the working can be found by consulting this paragraph. The first part concerns the machine working and includes a list of the possible defects with respective controls that must be made; the second part concerns the inconveniencies that can be found by checking the blade and / or the cut pieces. If your problem is not included in the mentioned ones or you need the presence of qualified technicians, please get in touch with the manufacturer or the reseller by keeping in evidence this instruction book .

12.1 - DEFECTS CAUSED BY THE MACHINE

Problem

- A* The band electric motor does not work
- B* The hydraulic circuit motor does not work
- C* The electronical/electric panel does not light on
- D* No enough pressure in the hydraulic circuit
- E* The pump of the hydraulic unit is noisy
- F* The coolant is not sufficient
- G* The workpiece moves or deforms
- H* The cycle don't start

Check

- 3-4-5-9
- 1-2-3-4-5-9-17
- 6-7-8-9
- 10-11-12-13
- 14-15-16-17
- 18-19-20-21
- 22-23-24
- 23

LIST OF THE PARTS THAT MUST BE CHECKED

- 1 = Plug is right inserted in the socket
- 2 = Main switch
- 3 = The motor is burnt or damaged
- 4 = Electric supply is not right
- 5 = Transmission blocked between blade and blade arbor
- 6 = Fuses on the primary of the transformer
- 7 = Fuses on the secondary of the transformer
- 8 = Transformer damaged or burnt
- 9 = Connection of the supply cables
- 10 = Oil level in the tank of the hydraulic unit
- 11 = Loss from pipes and/or connections
- 12 = The adjustments screw of the maximum pressure valveis loosened
- 13 = the maximum pressure valveis broken
- 14 = Quality of the hydraulic oil (consumed, too much liquid)
- 15 = There is some water in the oil and / or there is some condensate in the tank
- 16 = Too high circuit pressure (over 20 BAR)
- 17 = The hydraulic pump locked (seizure, expansion, oxidation)
- 18 = The circuit taps are closed
- 19 = The cooling filters are obstructed or must be cleaned
- 20 = The electropump does not work (see 3-4-5-9-24)
- 21 = The tank is empty or dirty
- 22 = Excessive cutting feed
- 23 = The vice is not closed enough (or is too closed), the piece is not rightly clamped
- 24 = The control LUBRICANT OFF is active (pos. 22 / dr. RI0055 for models SH-E, SHI-E)

12.2 - PROBLEMS OF THE BLADE / CAUSES / SOLUTIONS

In case of broken teeth, broken blades or short blade life, lay down the broken band on the floor and check the body and teeth defects; look for them in the following table and read the solution of the cutting problem .

1. PREMATURE AND EXCESSIVE TEETH WEAR AND TEAR

- thrust pressure to short: increase it;

INSTRUCTIONS FOR USE

- reduce the band wheel speed;
- cooling jet too short;
- improper cooling emulsion;
- uncorrect toothing: use a band with a thicker toothing;
- improper band-running-in;
- the teeth move towards the opposite cutting direction; turn the band.

2. BLADE VIBRATION

- Increase or reduce the band speed
- dull vibration: increase the band tension;
- too big teeth for the piece that must be cut;
- the vibration reverberates in the base; reduce the cutting pressure;
- the vibration could be due to the high frequency: increase the speed of the saw frame lowering;
- the material is not rightly locked;
- use a variable pitch or a positive toothing.

3. BROKEN TEETH

- Too big teeth for the section that must be cut;
- the material is not perfectly locked;
- improper coolant;
- inadequate coolant;
- cutting pressure too high: control the chip;
- too low band wheel speed;
- the grooves are full of cut material.

4. CUTTING SURFACE TOO ROUGH

- Choose a thinner pitch;
- increase the band wheel speed;
- reduce the head lowering;
- measure better the coolant.

5. PREMATURE BAND BREAKAGE

- Too high band thickness for the diameter of the band wheel;
- band guides too open with high speed;
- increase or reduce the speed;
- check if the band wheels are defective;
- too big toothing;
- band tension too high; the lying down band rises on the side;
- saw frame lowering too strong: the band back is polish and upset;
- The thrust bearings are not aligned with the band wheels: the lying band curves and the band back is polish and upset;
- the band guides are too tight: the lying band spirals up as a spring; the more the teeth are tight, the more the band twists;
- short coolant.

6. BENT CUTS

- Increase the band tension;
- approach the band guides to the cutting unit;
- the teeth are too thin;
- reduce the cutting pressure.

7. THE CUT IS NOT RIGHT

- Approach the band guides to the cutting unit;
- check if the cutting piece is rightly horizontally placed on the support table;
- control the band perpendicularity: if it is out of perpendicularity, work on the band guides;
- toothing too thick;
- the teeth are broken or variegated;
- increase the cutting speed.

8. BLADE NOISE ON THE THRUST BEARINGS

- Burr or adjust the band back;
- check the band wheel alignment;
- check the thrust bearing wear and tear;

INSTRUCTIONS FOR USE

- the welding is not perfect.

9. THE BLADE BENDS POSITIVELY

- Reduce the cutting pressure;
- use bigger teeth for increasing the penetration;
- approach the band guides to the cutting unit.

10. THE BAND BENDS NEGATIVELY

- The band back strains against the upper thrust bearing band guides; check if the space between the band back and the band wheel rim is always the same by band in movement and band stopped;
- check the alignment of the band wheels.

11. SLOW CUTTING, THIN CHIPS

- Increase the bend wheels speed;
- increase the cutting pressure;
- use bigger teeth;
- use a proper coolant.

12. PREMATURE LOSS OF THE SIDE SETTING

- Reduce the bad wheels speed;
- increase the distribution of the coolant.

13. THE BLADE TWISTS LIKE A SPRING

- Reduce the cutting pressure;
- reduce the band tension;
- excessive pressure on the band guides: adjust it;
- approach the bad guides to the cutting unit.

14. THE CHIP WELDS TO THE TOOTH / CHIPS ARE TOO BIG

- Reduce the cutting pressure
- use proper coolant and in a good quantity;
- check the wear and tear of the burst used for clening the chips from the grooves.

15. THE BLADE IS SIGNED OR SCRATCHED ON ONE SIDE

- Check the wear and tera of band pads;
- the pads press too much against the band back;
- check the alignment and the perpendicularity of the band guides.

16. BURR OR SWANGING ON THE BAND BACK

- Increase the tension and adjust the band guides;
- check the pressure and the alignment of the thrust bearings on the band back;
- reduce the cutting pressure;
- use a bigger toothing.

17. THE CUT PIECE HAS BLACK DIRT

- The band back touches the lip angle and becomes dirty;
- if the dirt is on the left side: the left band guide is out of axle;
- if the dirt is on the right side: the right band guide is out of square;
- the dirt is on the complete cutting line: the band guides are out of square, or: the pressure is too high; the band tension is too low; teeth are too thick and cannot set free from the dirt; the used coolant is wrong.

22 - MACHINE DEMOLITION



This paragraph may give some informations about the macrooperations of machine disassembly for its scrapping.

Special procedures are not required but it is necessary to take only some cares to avoid damages in the last phase of the machine life.

Generally: you must empty the cooling installation tank, take out the oil from the reduction box, from the hydraulic or hydropneumatic installation. **Lock the parts that could move and cause danger or instability.**

ISTRUZIONI PER L'USO-



Remove the parts assigned to the differentiated draining, for example the printed circuit, display stations,



programming keyboards, buffer batteries and so on, especially the ones which shows the picture . In these cases, in relation with the WEEE/AEEE Regulations ask to the supplier to know the right process, that depends by the machine size and purpose.



23 - SPARE PARTS

The choice of the required spare parts is aided by the included drawings that allow, together with the working schemes, to know better the machine.

17.1 - NORMS TO REQUEST THE SPARE PARTS



It is necessary to inform the TECHNICAL SERVICE about the following data:

- the serial number indicated on the identification plate
- model, version, type
- voltage and power frequency
- code number of the spare-parts
- requested quantity
- possibly the fittings assembled later

17.2 OILS AND LUBRICANTS (Comparison table marked RI0108):

MACHINERYHOUSE

ISTRUZIONI PER L'USO-

RI0108	#1		#2		#3			
GEBRAUCH	GETRIEBE		HYDRAULISCHER KREIS		PNEUM. KREIS	SCHMIERE	KUEHLMITTEL	
UTILISATION	ROUAGES DE LA TÊTE		CIRCUITS HYDRAULIQUES		CIRCUITS PNEUMATIQUES	GRAISSES	REFRIGERATION DE LA LAME	
USE	GEAR HEAD		HYDRAULIC PLANT		PNEUMATIC PLANT	GREASE	COOLANT	
USO	ROTISMI TESTA		CIRCUITI IDRAULICI		CIRC. PNEUMATICI	GRASSI	REFRIGERAZIONE LAMA	
	BS 280 BS 350	IDEAL PERFECT SIRIO RECORD	BS280 SH SIRIO VELOX	BS280 SHI/SHE VTF500 BS350 XT360 XT410			STAHL ACIER STEEL ACCIAIO	ALUMINIUM ALUMINIUM ALUMINIUM ALLUMINIO
 AGIP	BLASIA 100	BLASIA 220	OSO 15	OSO 46	ASP 3/C	GR MU 2	OXALIS 250	ULEX 100
 BRIT. PETROL.	(SAE 80-GL4) (150 cSt.)	ENERGOL GR-XP 220	ENERGOL HLP 15	ENERGOL HPL 46	ENERGOL HLP 32	ENERGREASE L2		
 CASTROL	ALPHA SP100	ALPHA SP220	HISPIN AWS15	HISPIN AWS46	HYSPIN AWS 32	SPHEEROL APT2	SUPEREDGE 4	SUPEREDGE 4
 CHEVRON	NL GEAR COMPOUND 100	NL GEAR COMPOUND 220	EP HYDRAULIC OIL 15	EP HYDRAULIC OIL 46	VISTAC OIL 68	DURA LIGHT GREASE 2	EP SOLUBLE	
 ESSO	SPARTAN EP 100	SPARTAN EP 220	NUTO H15	NUTO H46	NUTO H32	BEACON 2	KUTWELL 40	
 FINA	GIRAN 100	GIRAN 220	HYDRAN 15	HYDRAN 46	PURFIROK EP 32	MARSON EPL 2	PURFISOL PURFISOL LAM	PURFISOL IT4/018
 SHELL	OMALA OIL 100	OMALA OIL 220	TELLUS OIL 15	TELLUS OIL 46	TELLUS OIL S 32	ALVANIA GREASE R2	DROMUS OIL F	
 TOTAL	CARTER EP 100	CARTER EP 220	AZOLLA ZS 15	AZOLLA ZS 46	PNEUMA 46	NYCTEA 2	LACTUCA EP	LACTUCA EP
 TEXACO	MEROPA 100	MEROPA 220	RANDO OIL HD 15	RANDO OIL HD46		MULTIFAC EP 2		
 VANGUARD	GEARING EP 100	GEARING EP 220	HYDRAULIC 15	HYDRAULIC 46	KOMOL SRV 32	LIKO 2	VANSIN 80 EP	VANSIN 80 EP
 SINOL	SINTREX EP 100	SINTREX EP 220	SINOLUBE	SINOLUBE		BEARING EP 2	SINOL BIO 90	
 ITAL. PETROLI	MELLANA OIL 100	MELLANA OIL 220	HIDRUS OIL 15	HIDRUS OIL 46	BANTIA OIL R 32	ATHESIA GREASE 2	UTENS FLUID F	UTENS FLUID F
 CINCINNATI							CIMPERIAL C 60	CIMCOOL AL
ISO - UNI CLASS.	CC100	CC220	HM15	HM32	FD32	XM2		

ISTRUZIONI PER L'USO-

24 - MAINTENANCE - for skilled personnel

IMPORTANT

If you want to make some special maintenance/disassembly/resetting operations on the machine, it is necessary to know all information concerning safety procedures.

The skills of specialized personnel allow to solve more easily all problems found by the user when running the saw. This allows also to safeguard the technical, production and safety features of this equipment, according to the initial setting by the manufacturer.

To get a detailed knowledge of this machine you can find here enclosed:

- Electrical scheme/s: divided into theme tables and made according to the current norms concerning this subject, with index, material indication, reference code numbers.

- Pneumatic and hydraulic circuits

- Drawings: divided into the main parts the saw is comprised of. They code each mechanical component.

The electrical/electronic/pneumatic or hydraulic components are not showed in these drawings but only in the aforementioned schemes.

If the users want to know this saw in detail, they can study this manual and follow its indications meticulously, but they do not have to modify any parts of this equipment, since by doing so the DECLARATION OF CONFORMIITY would lose its validity

1	2	3	4	5	6	7	8	9	10	11	12	13	14	15	16	17	18	19	20	21	22	23	24	25	26	27	28																												
A																											A																												
B																											B																												
C	DEVICE DESIGNATIONS														CODE TO NUMBER AUXILIARY CONDUCTORS (ABCD)												C																												
D	AT	Main control	B	Proximity switch	BQ	Encoder	C	Capacitor	FU	Fuse block	KM	Control master relay	HL	Pilot light	E	L	Filter suppressor	M	Motor	PA	Ampermeter	QM	Circuit breaker	RP	Potentiometer	SA	Selector switch	SB	Pushbutton	SQ	Limit switch	ST	Thermic switch	H	TC	Control circuit transformer	TV	Voltage transformer	I	U	Controller A.C.	V	Rectifier diode	VC	Rectifier bridge	X	Terminal block	J	XS	Plug	XP	Receptacle	YV	Solenoid valve	K
E																											E																												
F																											F																												
G																											G																												
H																											H																												
I																											I																												
J																											J																												
K																											K																												
															MACCHINA TIPO: BS350/60AFI-NC ESC 400V Brah-Bcn DESCRIZIONE : Device designations Legenda simbologia elettrica																																								
3 2 1 N* DATA						MODIFICHE												DISEGNO N° : QE0254B2 FILE : 098..... Data : 09.2007 Foglio N° : 1																																					
1	2	3	4	5	6	7	8	9	10	11	12	13	14	15	16	17	18	19	20	21	22	23	24	25	26	27	28																												

ISTRUZIONI PER L'USO-

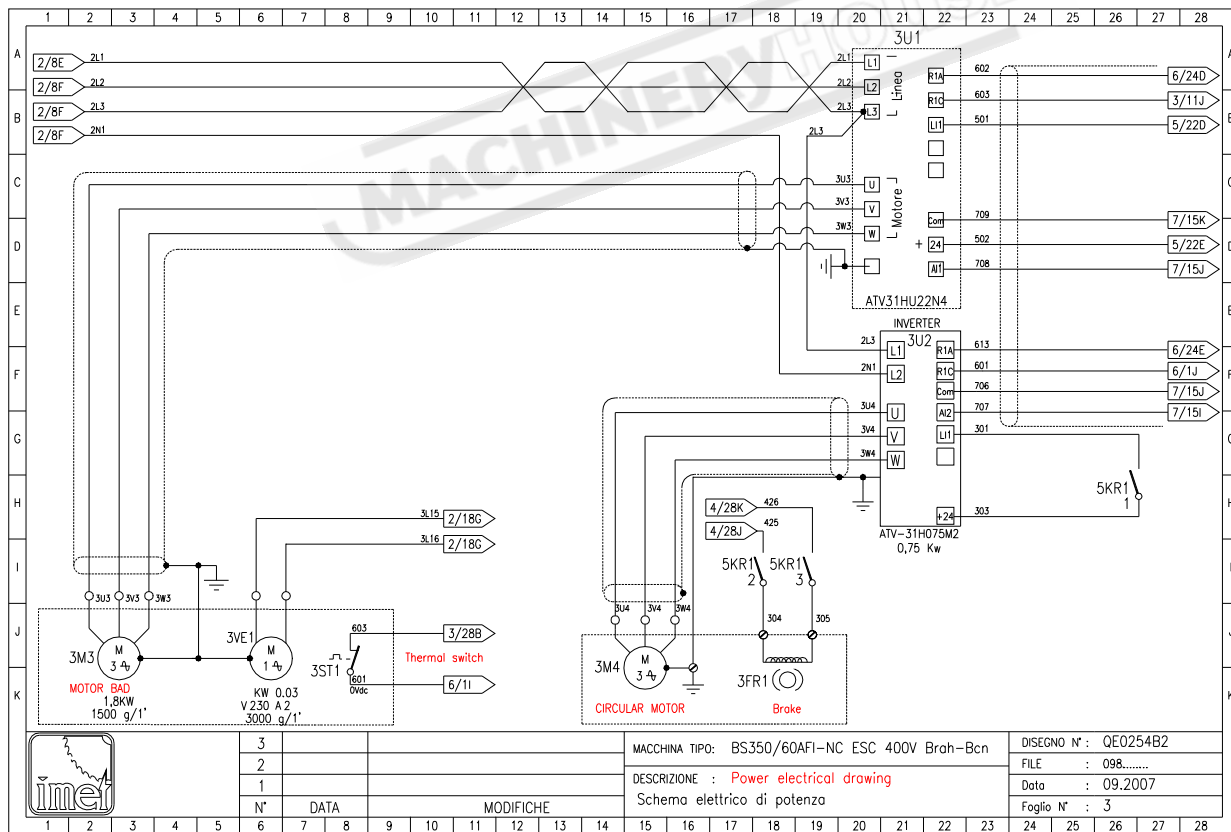
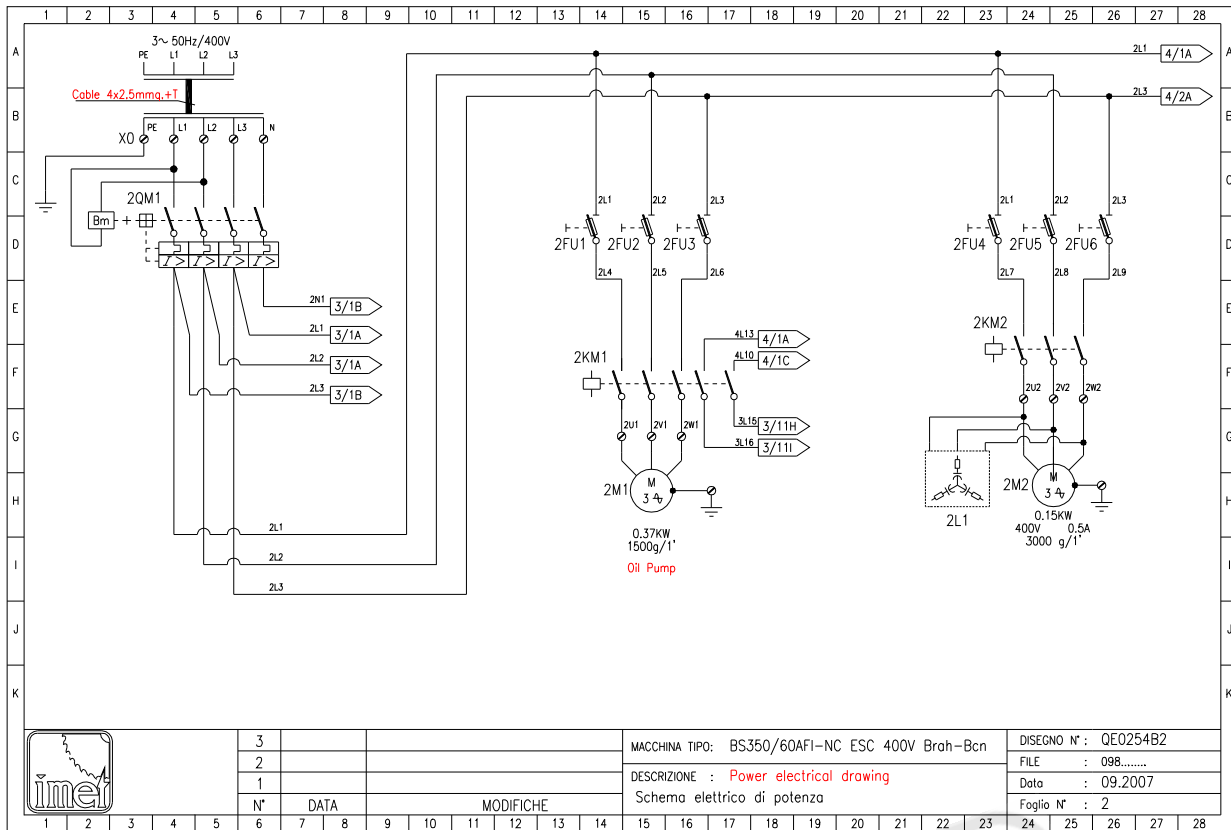

ISTRUZIONI PER L'USO

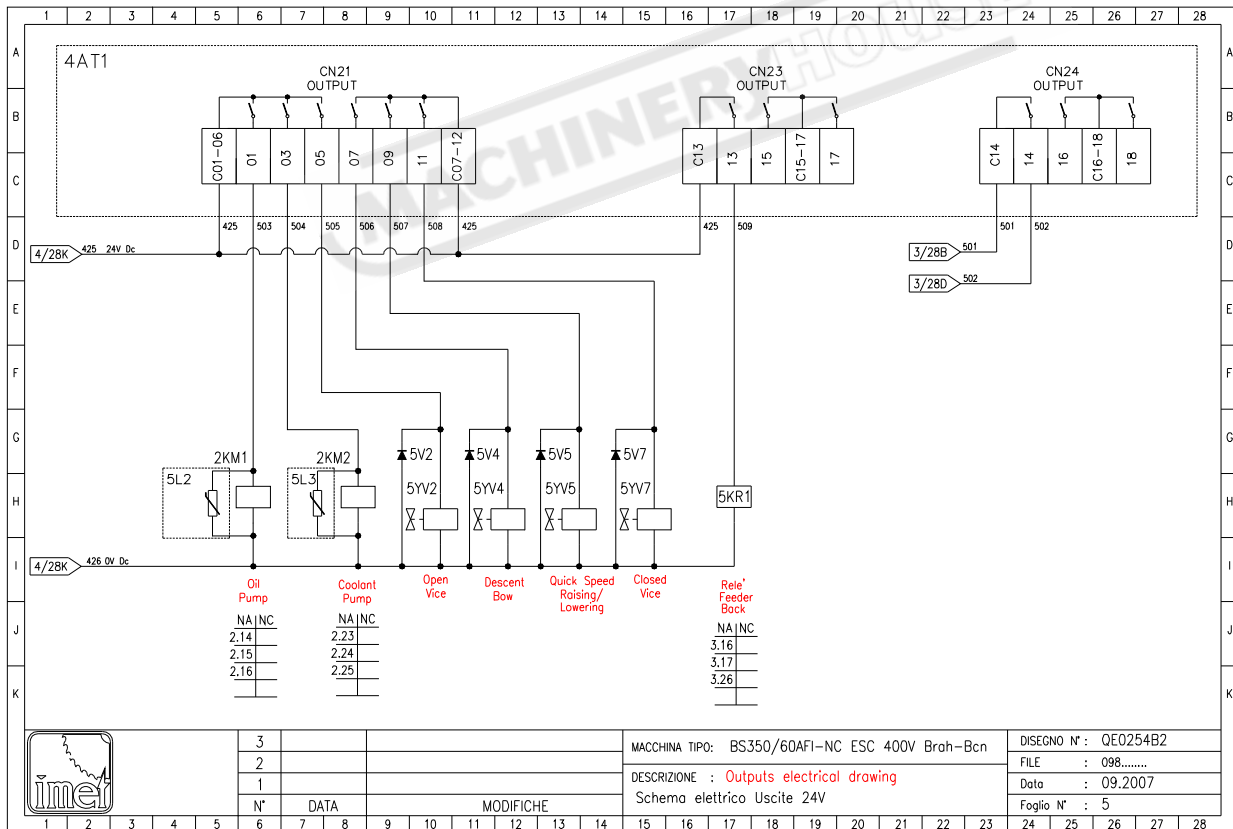
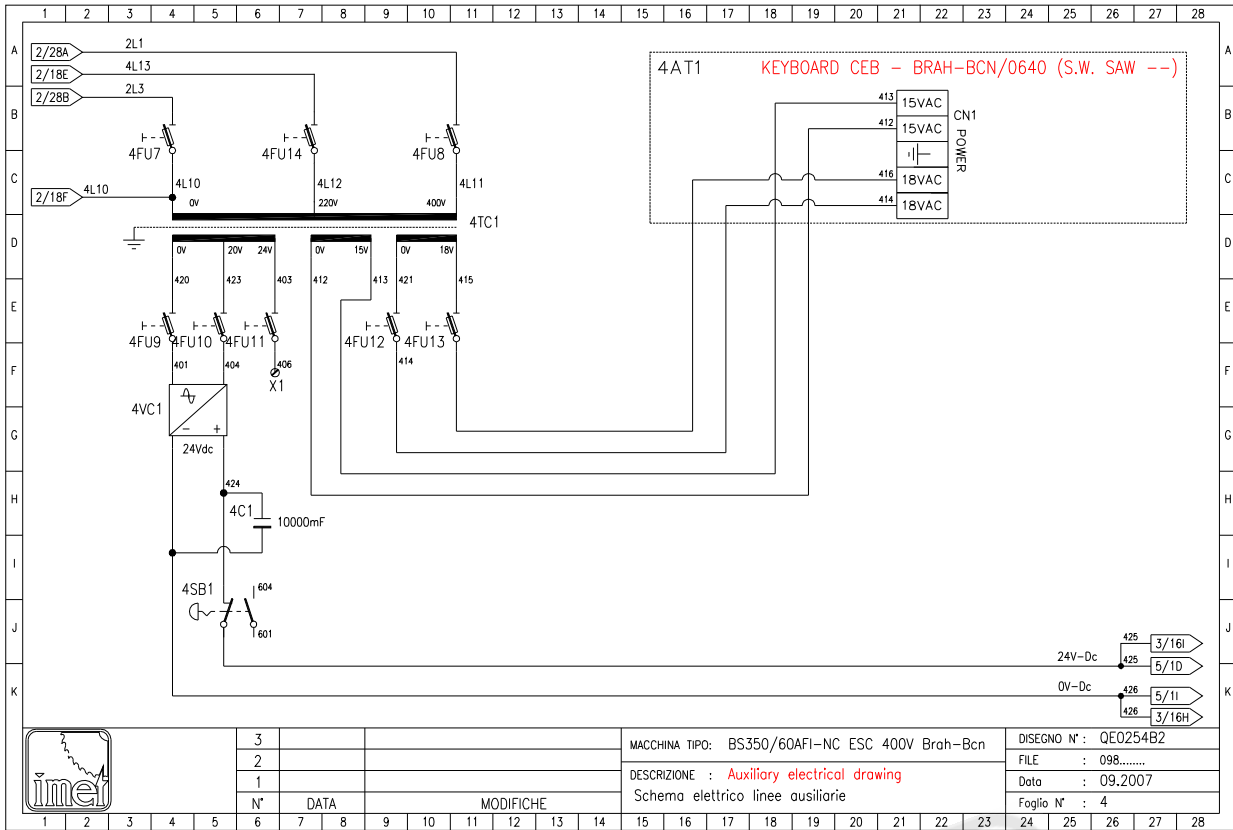

ISTRUZIONI PER L'USO-

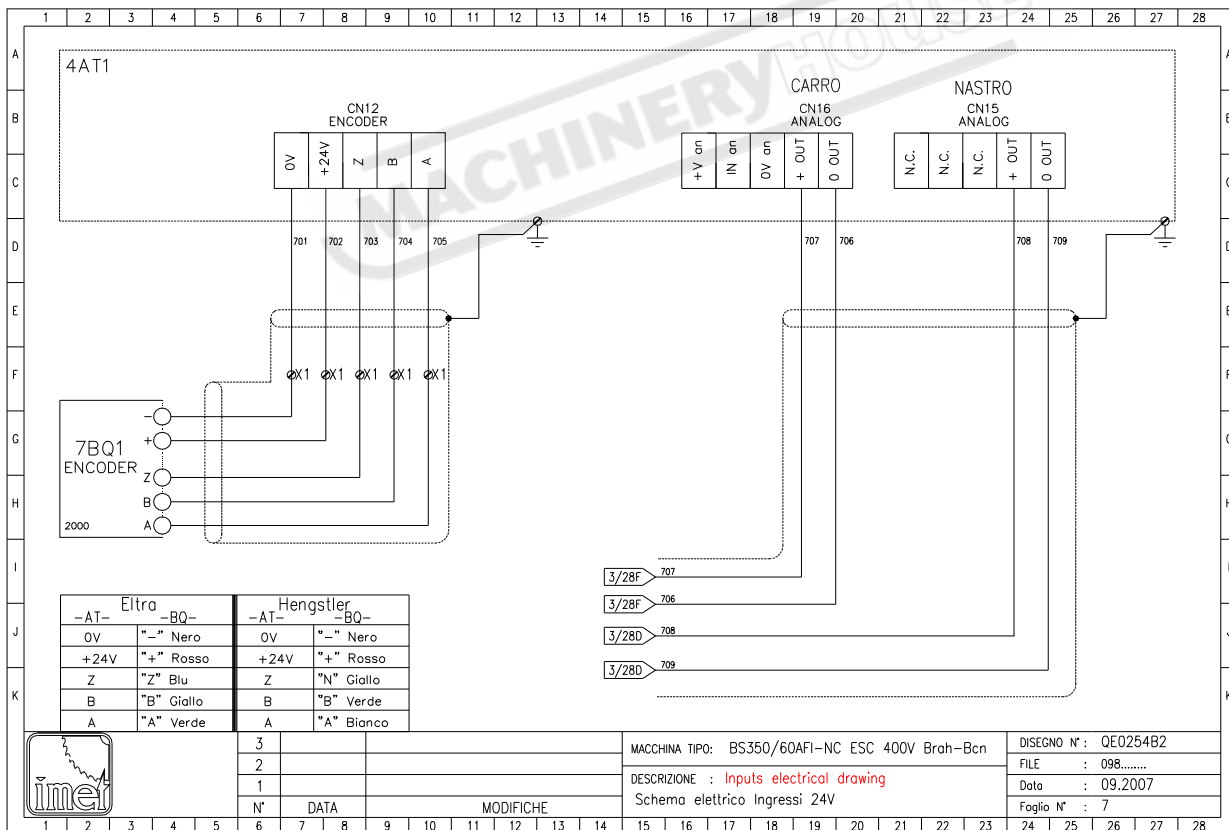
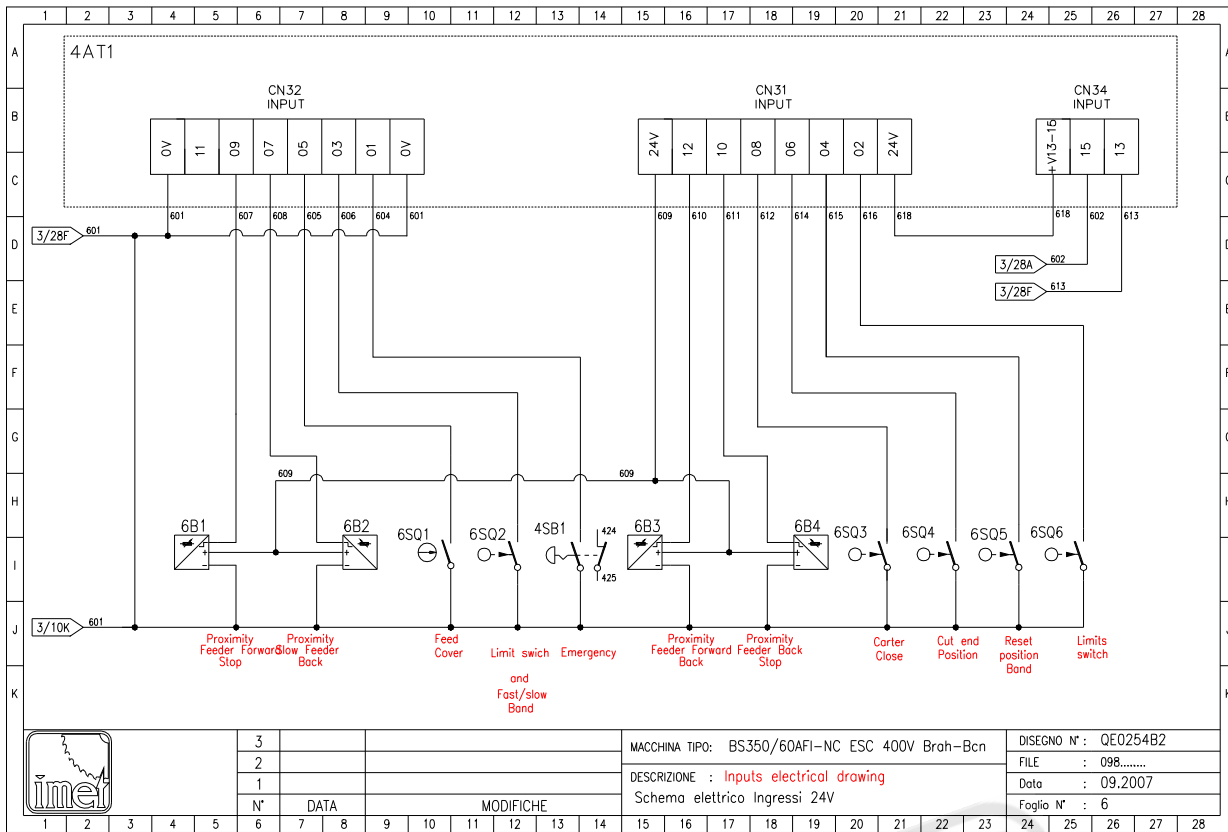

ISTRUZIONI PER L'USO

REF.	DEVICE	SPECIFICATIONS	FUNCTION	FACTORY	TYPE	ITEM N°	Q.TY
5KR1	Rele*	24 VAC	-	OMRON	MY4	-	1
5YV2	Conneter	AC 24V 4VIE+LED	Control	-	S18209TC42	260163	1
5YV4	Conneter	AC 24V 4VIE+LED	Control	-	S18209TC42	260163	1
5YV5	Conneter	AC 24V 4VIE+LED	Control	-	S18209TC42	260163	1
5YV7	Conneter	AC 24V 4VIE+LED	Control	-	S18209TC42	260163	1
6S01	Limit switch	IP65 - NC/0/NO	Control carter close	PIZZATO	-	-	1
6S02	Limit switch	IP65 with cable	Control workpiece position	TELEMECANIQUE	-	-	1
6S03	Limit switch	IP65 - NC/0/NO	Control carter close	PIZZATO	-	-	1
6S04	Limit switch	NO/0/NC	Control limit cut	-	ABV121260	520941	1
6S05	Limit switch	IP65 with cable	Control workpiece position	TELEMECANIQUE	-	-	1
6S06	Limit switch	IP65 with cable	Control reverse trolley	TELEMECANIQUE	-	-	1
6B1	Proximity	10-30V DC D.12	-	INFRA	IS61 NPN/NO	521134	1
6B2	Proximity	10-30V DC D.12	-	INFRA	IS61 NPN/NO	521134	1
6B3	Proximity	10-30V DC D.12	-	INFRA	IS61 NPN/NO	521134	1
6B4	Proximity	10-30V DC D.12	-	INFRA	IS61 NPN/NO	521134	1
7BQ1	Encoder		Feeder carriage position	ELTRA	EL40A2000Z5/28P6X3PR	331770	1
X1/2	Terminal block	Single terminal 2.5mmq/4A	Connections external equipments	CONTACLIP	RK 2.5 4PA	558790	48
X1/2	Terminal block	Morsetti terra Giallo/Verde	Connections external equipments	CONTACLIP	SL4	559090	3
X1/2	Terminal block	Morsetto d'estremita'	Connections external equipments	CONTACLIP	ES35	558810	3
cv0	Flexible cable	4x2.5mmq.	Connection main supply				
cv1	Flexible cable	3x1.5mmq. Schermato	Connection motor				
cv2	Flexible cable	4x1.5mmq.	Connection motor coolant				
cv3	Flexible cable	3x1.5mmq+Shield	Connection motor band				1



3	
2	
1	
N°	DATA

MODIFICHE	
-----------	--

MACCHINA TIPO: BS350/60AFI-NC ESC 400V Brah-Bcn

DESCRIZIONE : General list of electrical equipments

Elenco generale componenti elettrici

DISEGNO N° : QE0254B2

FILE : 098.....

Data : 09.2007

Foglio N° : 13

REF.	DEVICE	SPECIFICATIONS	FUNCTION	FACTORY	TYPE	ITEM N°	Q.TY
5KR1	Rele*	24 VAC	-	OMRON	MY4	-	1
5YV2	Conneter	AC 24V 4VIE+LED	Control	-	S18209TC42	260163	1
5YV4	Conneter	AC 24V 4VIE+LED	Control	-	S18209TC42	260163	1
5YV5	Conneter	AC 24V 4VIE+LED	Control	-	S18209TC42	260163	1
5YV7	Conneter	AC 24V 4VIE+LED	Control	-	S18209TC42	260163	1
6S01	Limit switch	IP65 - NC/0/NO	Control carter close	PIZZATO	-	-	1
6S02	Limit switch	IP65 with cable	Control workpiece position	TELEMECANIQUE	-	-	1
6S03	Limit switch	IP65 - NC/0/NO	Control carter close	PIZZATO	-	-	1
6S04	Limit switch	NO/0/NC	Control limit cut	-	ABV121260	520941	1
6S05	Limit switch	IP65 with cable	Control workpiece position	TELEMECANIQUE	-	-	1
6S06	Limit switch	IP65 with cable	Control reverse trolley	TELEMECANIQUE	-	-	1
6B1	Proximity	10-30V DC D.12	-	INFRA	IS61 NPN/NO	521134	1
6B2	Proximity	10-30V DC D.12	-	INFRA	IS61 NPN/NO	521134	1
6B3	Proximity	10-30V DC D.12	-	INFRA	IS61 NPN/NO	521134	1
6B4	Proximity	10-30V DC D.12	-	INFRA	IS61 NPN/NO	521134	1
7BQ1	Encoder		Feeder carriage position	ELTRA	EL40A2000Z5/28P6X3PR	331770	1
X1/2	Terminal block	Single terminal 2.5mmq/4A	Connections external equipments	CONTACLIP	RK 2.5 4PA	558790	48
X1/2	Terminal block	Morsetti terra Giallo/Verde	Connections external equipments	CONTACLIP	SL4	559090	3
X1/2	Terminal block	Morsetto d'estremita'	Connections external equipments	CONTACLIP	ES35	558810	3
cv0	Flexible cable	4x2.5mmq.	Connection main supply				
cv1	Flexible cable	3x1.5mmq. Schermato	Connection motor				
cv2	Flexible cable	4x1.5mmq.	Connection motor coolant				
cv3	Flexible cable	3x1.5mmq+Shield	Connection motor band				1



3	
2	
1	
N°	DATA

MODIFICHE	
-----------	--

MACCHINA TIPO: BS350/60AFI-NC ESC 400V Brah-Bcn

DESCRIZIONE : General list of electrical equipments

Elenco generale componenti elettrici

DISEGNO N° : QE0254A2

FILE : 098.....

Data : 10.2006

Foglio N° : 13

ISTRUZIONI PER L'USO

REF.	DEVICE	SPECIFICATIONS	FUNCTION	FACTORY	TYPE	ITEM N°	Q.TY
cv4	Flexible cable	2x0.75mmq.	Connection termik				
cv5	Flexible cable	3x0.25mmq. Schermato	Connection solenoid valves and limits switch				
cv6	Flexible cable	2x0.75mmq.	Limits switch				
cv7	Flexible cable	2x0.75mmq.	Limits switch				
cv8	Flexible cable	2x0.75mmq.	Connection solenoid valves				
cv9	Flexible cable	2x0.75mmq.	Connection solenoid valves				
cv10	Flexible cable	2x0.75mmq.	Connection solenoid valves				
cv11	Flexible cable	4x1.5mmq.	Connection motor oil				
cv12	Flexible cable	5+1x0.75mmq. schermato	Connection encoder				
cv13	Flexible cable	2x0.75mmq.	Limits switch				
cv14	Flexible cable	2x0.75mmq.	Limits switch				
cv15	Flexible cable	3x0.75mmq.	Proximity				
cv16	Flexible cable	3x0.75mmq.	Proximity				
cv17	Flexible cable	2x0.75mmq.	Limits switch				
cv18	Flexible cable	3x0.75mmq.	Proximity				
cv19	Flexible cable	3x0.75mmq.	Proximity				
cv20	Flexible cable	2x0.75mmq.	Limits switch				
cv21	Flexible cable	2x0.75mmq.	Connection solenoid valves and limits switch				
cv22	Flexible cable	2x1.5mmq.	Connection				
gn3	Flexible tube	PVC 1"	Output	TEAFLEX			1

	3			MACCHINA TIPO: BS350/60AFI-NC ESC 400V Broh-Bcn	DISEGNO N° : QE0254B2
	2			DESCRIZIONE : General list of electrical equipments	FILE : 098.....
	1			Elenco generale componenti elettrici	Data : 09.2007
	N°	DATA	MODIFICHE		Foglio N° : 14

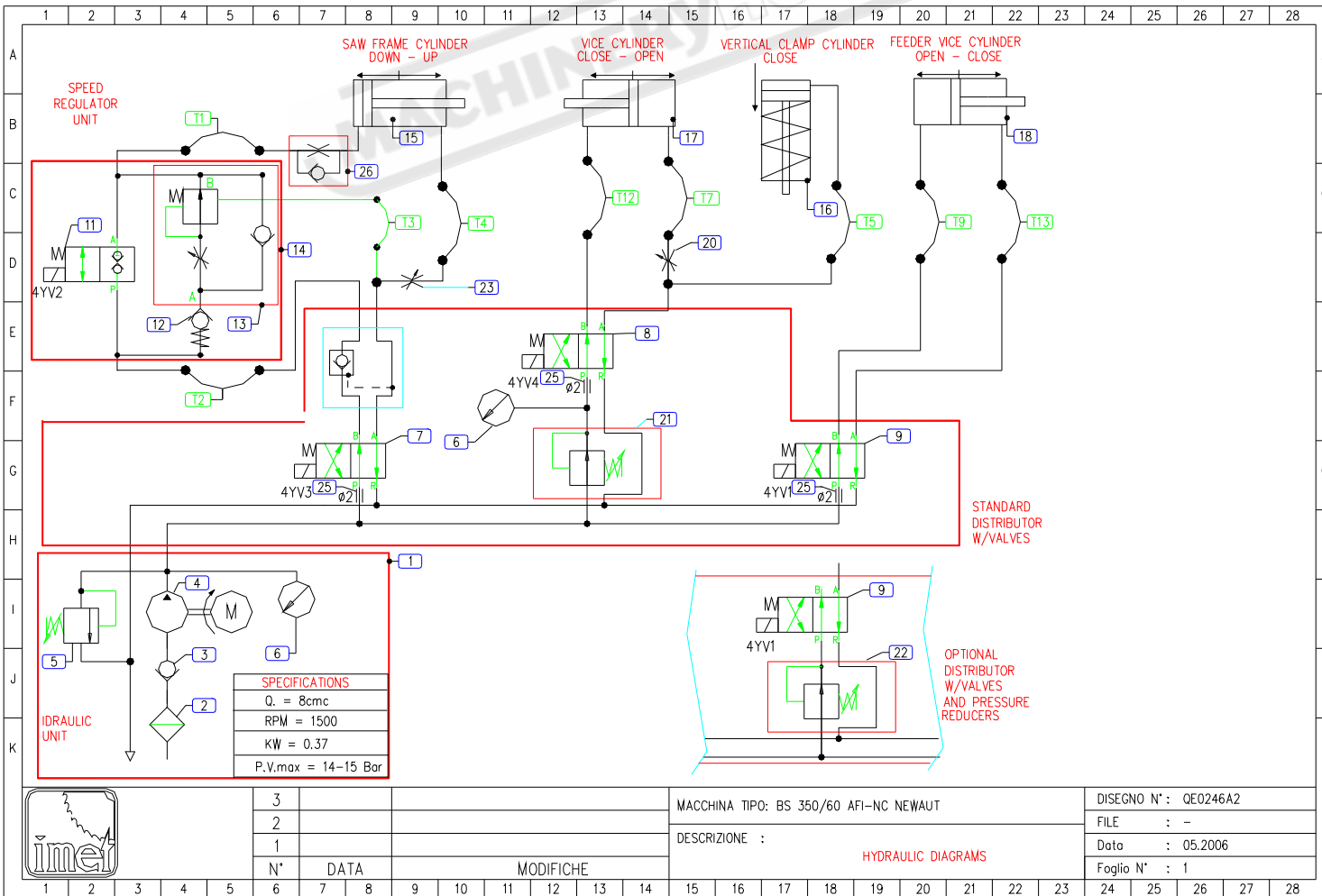

ISTRUZIONI PER L'USO-

REF.	DESCRIPTION	SPECIFICATION	FACTORY	TYPE	PART NUMBER	Q.TY
1	COMPLETE HYDRAULIC UNIT	MODULAR ELEMENTS w/MOTOR 6POLES 0.25KW	IMET			1
2	OIL FILTER	D. 80 X 28	ARON		-	1
3	ONE-WAY CHECK VALVE	CARTRIDGE TYPE	ARON		-	1
4	HYDRAULIC PUMP	9.2 cc	Marzocchi	KIPS 9.2 G	-	1
5	MAX. PRESSURE CONTROL VALVE	0 - 50 BAR	ARON	V388916A04	-	1
6	PRESSURE GAUGE	0 - 40 BAR	WIKI	113-13-063	539877	1
7/8	DIRECTIONAL CONTROL VALVE/ONE POSITION	4/2 - Tensione 24Vd.c.	ARON	AD3E15A	331541	1
9	DIRECTIONAL CONTROL VALVE/ONE POSITION	4/2 - Tensione 24Vd.c.	ARON	AD3E15A	331541	1
11	DIRECTIONAL CONTROL VALVE/TWO WAY-TWO POS.	CARTRIDGE TYPE	COMATROL	EVH-06-C5-24C-00	331699	1
12	ONE-WAY CHECK VALVE	CARTRIDGE TYPE	COMATROL	RC 06-05-00	202202	1
13	SPEED REGULATOR	FLOW RATE =3 LT/MIN	ARON	QCV32GK2R	727035	1
14	COMPLETE SPEED REGULATOR UNIT	-	IMET	-	F70340	1
15	DOUBLE ACTING SAW FRAME CYLINDER	D. 50	GHETTI	-	222830	1
16	SINGLE ACTING VERTICAL VICE CYLINDER	-	IMET	-	T40002	1
17	SINGLE ACTING VICE CYLINDER	D. 70X10	GHETTI	-	T22731	1
18	SINGLE ACTING FEEDER VICE CYLINDER	D. 70X10	GHETTI	-	T22733	1
20	ADJUSTABLE FLOW CONTROL VALVE	3/8 MF	SIRAL	N.405 3/8 MF	755901	1
21/22	OPTIONAL	PRESSURE REGULATOR VALVE	IMET	-	000964	1+1
23	ON/OFF Cock	1/4" female/female	AIGNEP	A 400 FF 1/4"	755888	1
24	PILOT CHECK VALVE (only from 12/98)	MIN. PRESSURE 1 BAR	ARON o ATOS	AM3UPA1 o HR013/-	940000	1
25		D2H11	IMET		172255	4
26	REGULATOR	D.1mm	IMET	FPRU-1/4-0,5-1	727041	1



3		
2		
1		
N°	DATA	MODIFICHE

MACCHINA TIPO: BS 350/60 AFI-NC NEWAUT	DISEGNO N° : QE0246A2
DESCRIZIONE : GENERAL LIST OF COMPONENTS	FILE : -
	Data : 05.2006
	Foglio N° : 3

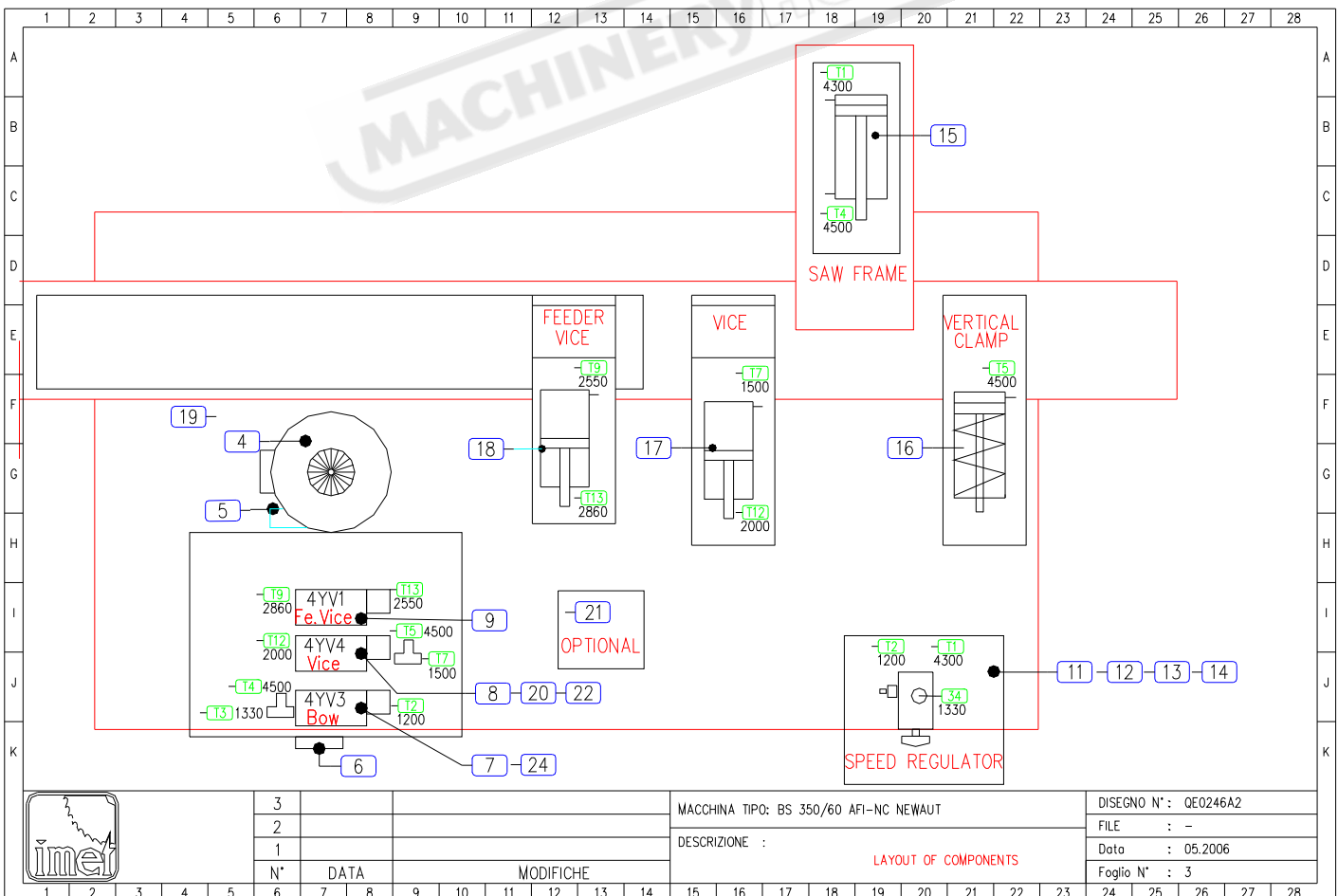

ISTRUZIONI PER L'USO-

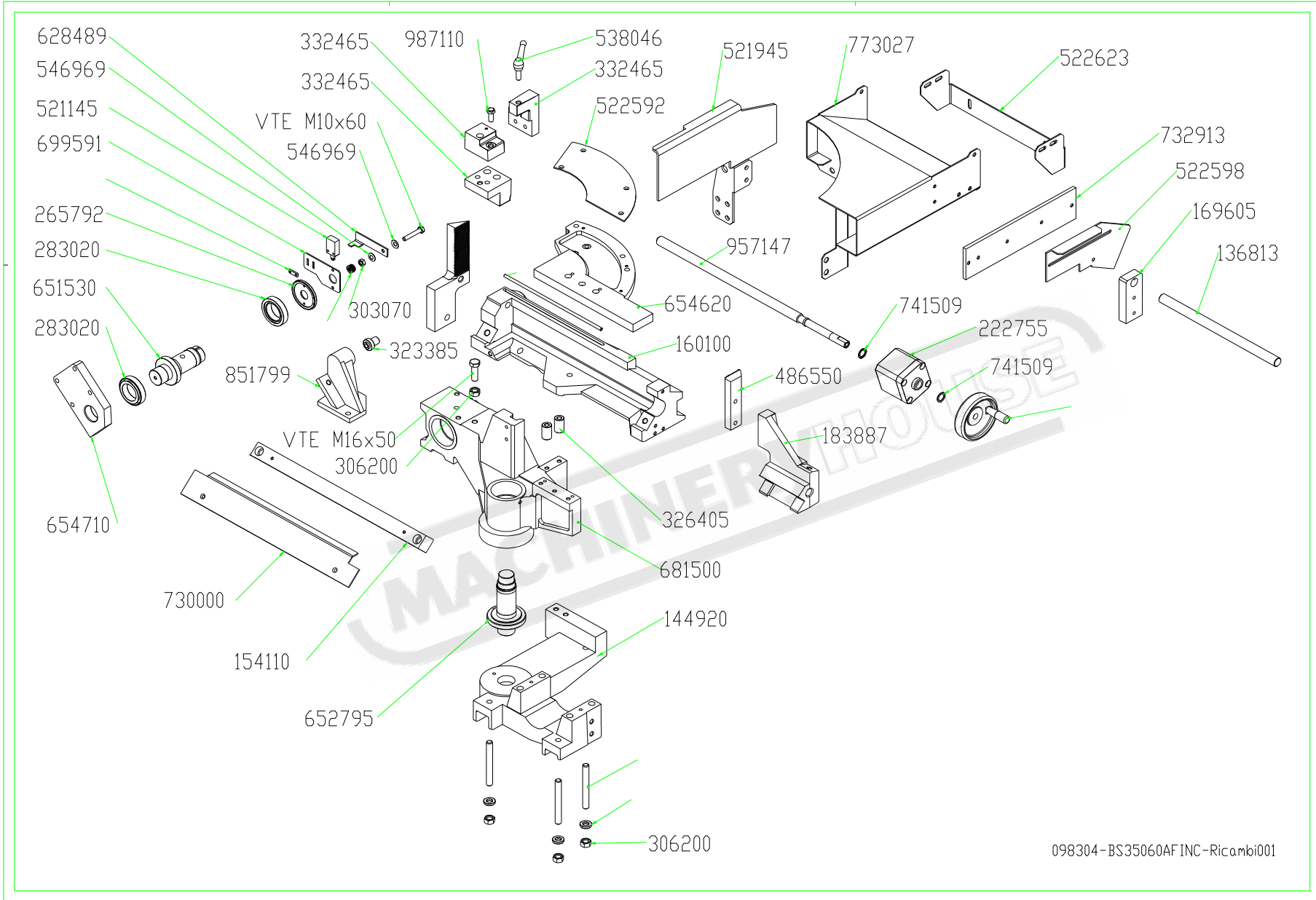

098304 - BS35060AF INC - Ricambi001

ISTRUZIONI PER L'USO-

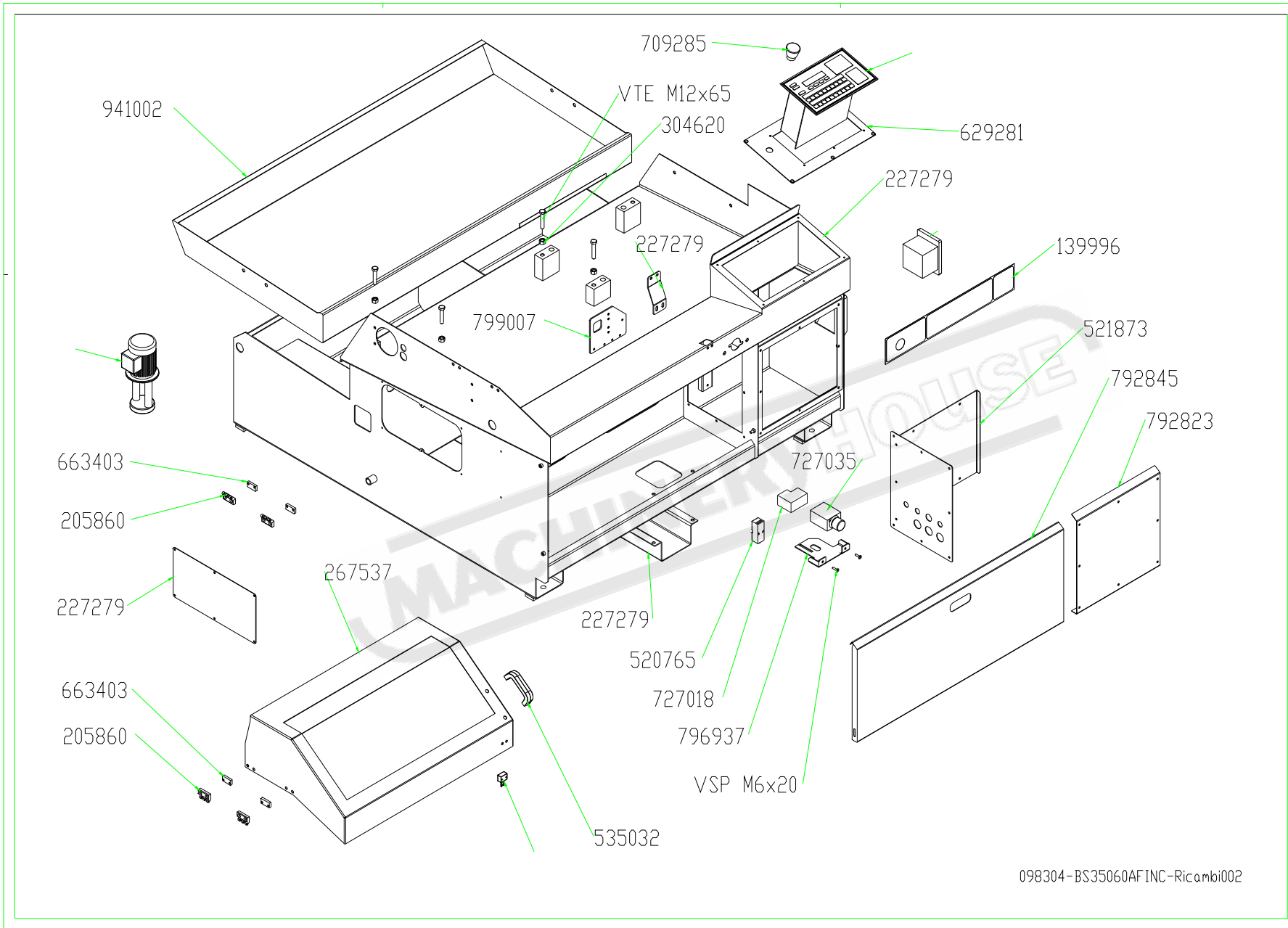

098304-BS35060AFINC-Ricambi002

ISTRUZIONI PER L'USO-

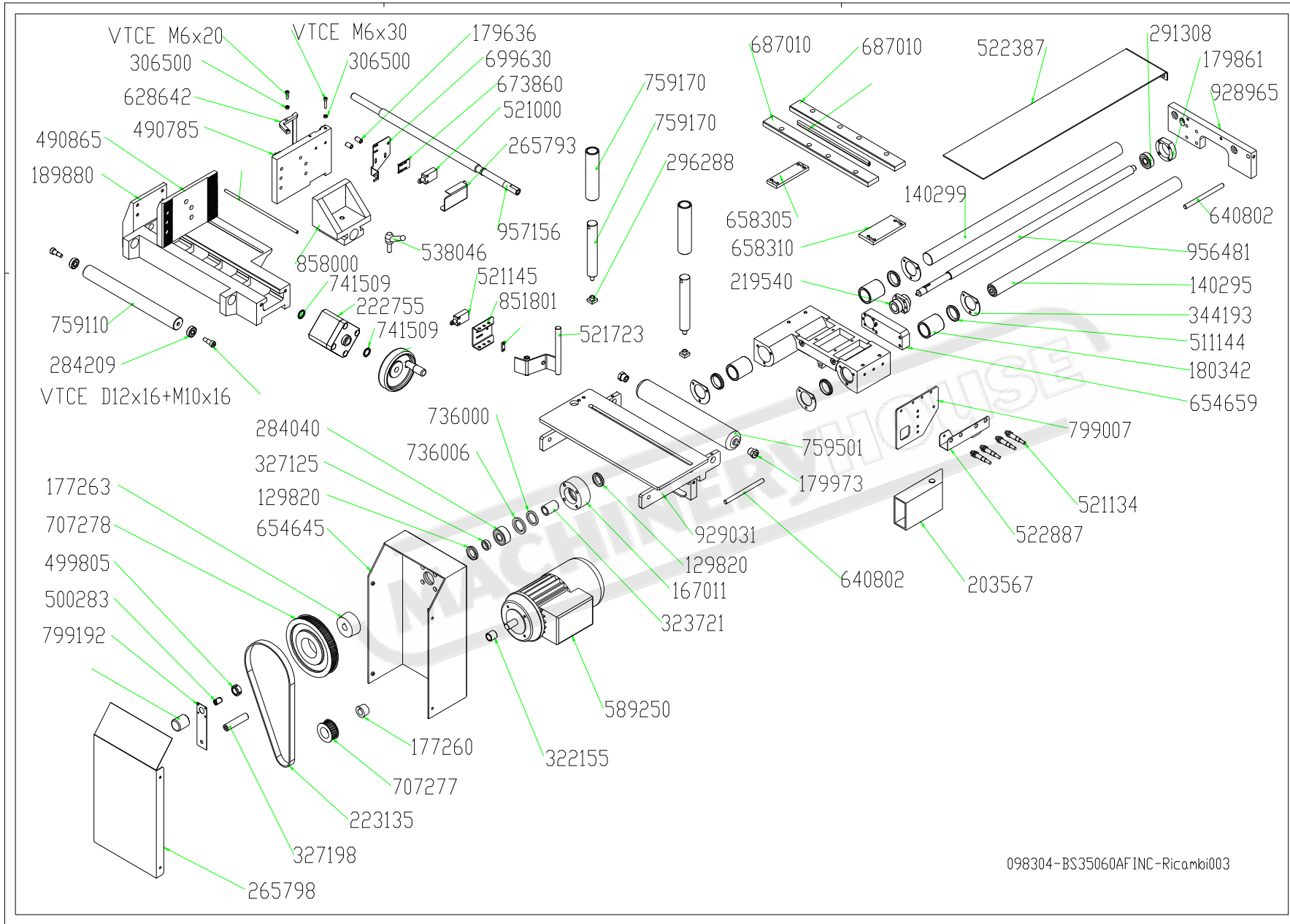

098304-BS35060AFINC-Ricambi003

ISTRUZIONI PER L'USO

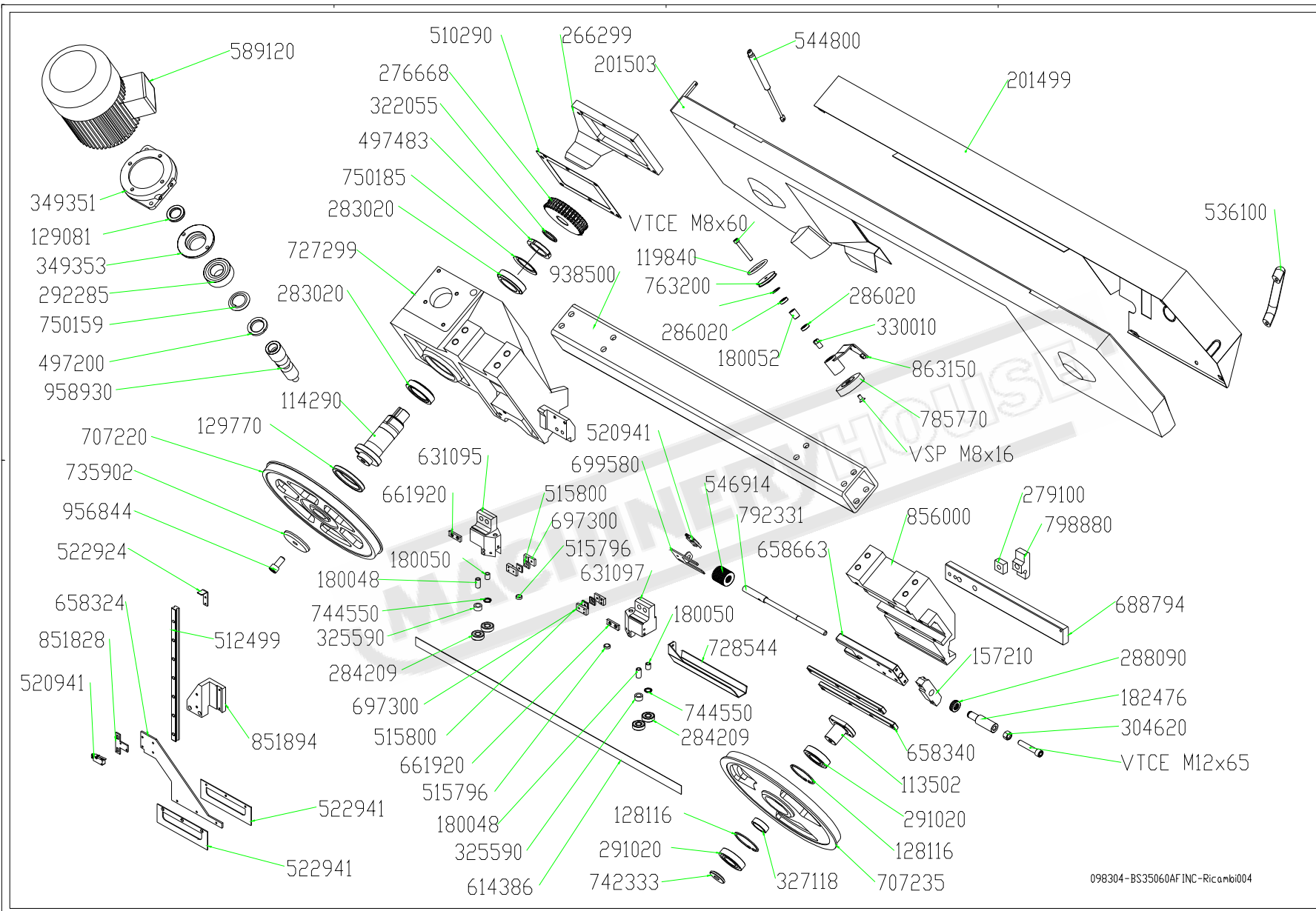

098304-BS35060AF INC-Ricambi004

ISTRUZIONI PER L'USO

COD.	ITALIANO	ENGLISH	FRANCOISE	DEUTSCH
098304	BS350/60AFI-NC/ESC NEWAUT 400V 16/90 SEGATRICE	BS 350/60 AFI-NC/ESC NEWAUT	BS 350/60AFI-NC/ESC NEWAUT	
113502	ALBERO X PULEGG.ANT.BS280 FRES ATO	BS 280 FRONT BAND WHEEL SHAFT		BS 280 VORDERSCHEIBE SAEGEARM
114290	ALBERO PORTA PULEGG.POST.BS350	BS350 BACK BAND WHEEL SHAFT		BS350 RUECKSCHEIBE WELLE
118842	ANELLO ANTIESTR.BRS230 CIL.PN. KS450/600/	BACK-UP RING BRS230		
119000	ANELLO TENUT.OR4093 3,53X23,40	SEAL RING OR4093 3,53X23,40		
119574	ANELLO TENUTA OR 3275 2,62X69, 52	OR RING 3275 2,62X69		
119576	ANELLO TENUTA OR3300 2,62X75,8 7	SEAL RING OR3300 2,62X75,87		
119588	ANELLO TENUTA OR4118 3,53X29,7 5	OR RING D.3,53X29,75		
119603	ANELLO TENUTAOR4250 3,53X63,09	SEAL RING OR4250 3,53X63,09		
119840	ANELLO TENUTA OR 6187 5,34X47	OR RING 6400 3,34X47	BOUCLE OR 6187 5,34X47	DICHTRING OR 6187 5,34X47
127810	ANELLO SEEGER A17 RIGA RTD	SEEGER RING A17 RTD TABLE		
128030	ANELLO SEEGER J22 SPAZZ. BS350	SEEGER RING J22 / BS350 BRUSH		
128116	ANELLO SEEGER J72 PULEGGE FORO 72	SEEGER INNER RING J72	BOUCLE SEEGER J72 POULIES	SEEGER INNERER RING J72
129696	ANELLO TENUTA 40X55X7	SEAL RING 40X55X7	JOINT 40X55X7	
129770	ANELLO TENUTA 75X95X12	SEAL RING 75X95X12		DICHTUNGSRING 79X95X12
129820	ANELLO TENUTA 30X42X7			
136813	ASTA X RISCONTRO SCAR.350/60AF I-NC D.25	ROD FOR LENGTH STOP 350/60 D25		
139999	AUT.DIS.ARCO BS350/60AFI- NC NE WAUT (SU COLONNA)			
140295	BARRA CROM.40X788 AVANZAT.IMET LARGH.300/400 CON RETE PROTEZ	FEEDER CHROM.BAR 40X788		
140299	BARRA CROM.40X807 AVANZAT.BS35 0/60	40X807 CHROM. BAR BS35 FEEDER		
144920	BASE APPOGGIO BS350/60 NC LAVO RATO	BS350/60NC WORKED BASE SUPPORT		
154110	BLOCCHETT.GUIDA MORSA BS350/60	BS350/60 VICE BLOCK GUIDE		
157210	BLOCCHETTO TENDINASTRO 280350 FRONTALE	BAND TENSIONER BLOCK 280350NEW		
160100	BLOCCO MORSA BS350/60 NC LAVOR ATO	BS350/60 NC VICE BLOCK		
167011	BOCCOLA CUSC.VSF.BS300AFI-NC D.90X43X32	-		
169600	BRACCIO PORT.PRES.MORSA BS350A FI-E	VICE PRESS.SUPPORT BS350AFIE		
169605	BRAC.PORT.RISC.SCARI.BS35 0/60A FI-NC	VICE PRES.SUPPORT BS350/60"NC"		
177260	BUSSOLA CONIC.TAPERL.1008-D19 (PER PULEGGIA B22S8M20)			
177263	BUSSOLA CONIC.TAPERL.2012-D20 (PER PULEGGIA B72S8M20)			
179458	BUSSOLA DISTANZ.D.6,5X10X14	SPACER D.6,5X10X14		
179820	BUSSOLA BLOC.PRES.MORSA BS350A FI-E	VICE PRESS.LOCKING BUSH BS350A		
179861	BUSSOLA CUSC.VITE AVZ.BS300 NC D.40X70X16	FEEDER BEARING SCREW BUSH		
179973	BUSSOLA X REGISTR.RULLO NEWAUT (BS280-350)	BUNDLE		
179990	BUSSOLA X VOLAN.MOLLE BS350 GH GRAVITA'	SPRINGS WHEEL BUSH BS350GH		

ISTRUZIONI PER L'USO

180048	BUSSOLA 8X12X25 PATT.350450	LEFT BAND GUIDE BUSH BS350		LINKE BANDFUEHRUNGSSCHUH BUCHSE
180050	BUSSOLA 8X12X15 PATT.350450600	RIGHT BAND GUIDE BUSH BS350		RE.BANDFUEHRUNGSSCHUH BUECHSE
180052	BUSSOLA DISTANZ.SPAZ.D16 BS350	SPACER D16 BS350		DISTANZBUECHSE D16 BS350
180342	BUSSOLA A SFERE 0658-240- 40 CO MPACT STAR 40X52X60	BALL BUSH 0658-240-40	2	
182433	BUSSOLA TEMP.10X15X12 DIN179/A	TEMPERATED BUSH 10X15X12		
182466	BUSSOLA TEMP.12X18X12 DIN179/A	TEMPERATED BUSH 12X18X12		
182476	BUSSOLA TENDINASTR.300350 NEWA UT	BAND STRETCHER BUSH		
182946	CAPICORD.OCCH.11039112=6, 5X6 GIALLO BM 00331			
183887	CARRELLO MORSA BS350/60 LAVORATO X NC	BS350/60 CARRIAGE VICE WORKED		
188051	CARRELLO HIWIN HGW15CAZ0C X GU IDE SENZA PRECARICO	HIWIN HGW15CAZ0C CARRIAGE		-
188500	CARRO INFER.AVANZ.BS350/60LAVO RATO X NC	BS350/60		
189880	BLOCCO MORSA PINZA 350/60LAVORATO AFI-NC (AVANZATORE)	BLOCK VICE PINCER 350/60		
201499	CARTER COPRITUBO FIS.12" BS350 UNIFICATO	TUBE GUARD 12" BS350		
201503	CARTER NASTRO-2PEZZI-12" BS350 UNIFICATO	BAND GUARD-2 PIECES- BS350		
203567	CATENA PORTACAV.Z1MN556075 AUT OM. NEW 350	CABLES HOLDER CHAIN Z1MN556075		
205260	CENTRALIN.ARON 3 POS.COMPL+MOT MONTARE:BS280 AFI-NC	-		
205860	CERNIERA ART.401-30-M6 BOTECO PER XT410	ITEM 40-30-MT6 BOTECO HINGE		
214680	CHIAVETTA 6X6X10 UNI6604	KEY 6X6X10		
214720	CHIAVETTA 6X6X25 UNI6604	KEY 6X6X25 UNI6604		
216270	CHIAVETTA 8X7X25 UNI6604	KEY 8X7X25 UNI6604		TL CLAVETTE ENTR.BAGUE
219540	CHIOCCIOLA FH2510 SENZ.FLANGIA PER BS280/60 AFI-NC	-		-
222755	CILINDRO MORSA KS450/600 80X10	VICE HYDR. CYLINDER KS450		SCHRAUBSTOCK HYDR.ZYLINDER 450
222830	CILINDRO IDRAUL.ARCO 350 TIPO 50X140 AVVITATO	CYLINDER SHI D.50		
222965	CILINDRO INT.PRES.MORSA BS350A FI-E	VICE PRESSURE INTER.CYLINDER		
222966	CILINDRO EST.PRES.MORSA BS350A FI-E	VICE PRESSURE EXT.CYLINDER 350		
223135	CINGHIA 200S8M960 SUPERTOR 280 AFI NC - XT410	-		
227279	COLONNA BS350/60AFI-E NEWUT (NEW01-2-2-2)	BASE FOR NEWAUT 350ROT		GRUNDLAGE NEWAUT 350 ROT
260163	CONNETTORE 4VIE+LED=S18209TC42 1 DIN43650A TRASPARENTE	4WAYS+LED CONNECTOR		4WEGE+LED VERBINDER
262000	CONTRODADO OTTONE 1/4 BM2460	BRASSED COUNTERNUT 1/4 GAS		
265792	COPERCHIO PORTA CAMMA BS350 GH GRAVITA'	CAM HOLDER COVER BS350 GH		
265798	COPERCHIO PULEG.AVZ.BS300 NC	FEEDER PULLEY COVER NEW280NC		
266299	COPERCHIO RIDUTTORE BS350 LAVO RATO	GEAR BOX COVER		REDUKTIONSGETRIEBE DECKEL
267537	COPRIAVANZAT.NEWAUT.350	FEEDER COVER NEWAUT 350		
276668	CORONA BRONZO BS350 M3 Z37	BRONZE WHEEL BS350 ME Z37		BRONZENRAD BS 350

ISTRUZIONI PER L'USO

279100	CUNEO X STAFFA GUIDALAMA BS350	WEDGE FOR BANDGUIDE ROD BS350		KEIL FUER BANDFUEHRUNGSTANGE
280765	CUSCINETTO RULLINI HK1616 APER TO	HK1616 CARRIAGE CONNECTION		LAGER HK1616 OFFEN
283020	CUSCINETTO 32010X 50X80X20	CARR.CONN. 32010X 50X80X20	ROULEMENT 32010X50X80X20	LAGER 32010X 50X80X20
284040	CUSCINETTO 3304.TVH 20X52X22.2	-		
284209	CUSCINETTO 6201.2ZR 12X32X10	BEARING 6201.2ZR 12X32X10		LAGER 6201 2ZR 12X32X10
286020	CUSCINETTO 608.2ZR 8X22X7	BRUSH/PUMP CARRIAGE CONNECTION	ROULEMENT 608.2ZR 8X22X7	
288090	CUSCINETTO ASS.51103 17X30X9	BEARING 51103 .X.X.		
291020	CUSCINETTO 6207.2RSR 35X72X17	CARRIAGE CONNECTION 6207 35X72		LAGER 6207EE 35X72X17
291308	CUSCINETTO 6303.2RSR 17X47X14	BEARING 6303 2RSR 17X47X14		
292285	CUSCINETTO 3207A 35X72X27	CARR.CONN. 3207A 35X72X27	2	LAGER 3207A 35X72X27
322055	DISTANZIALE AGGIUST.CORONA 350	WHEEL ADJUSTING SPACER 350		SCHNECKENRAD DISTANZSTUECK 350
322155	DISTANZIALE MOT.CARRO 280/60NC 25X19X23 FOSFATATO	-		
323380	DISTANZIALE POST.CIL/RIDUT 350	CYLINDER BACK SPACER 350		ZYLINDER/REDUKT.RUECKDIS TAZSTU
323385	DISTANZIALE ANT.CIL/PIATT. 350	CYLINDER FRONT SPACER 350		ZYLINDER VORDERDISTANZSTUECK
323721	DISTANZ.CUSC.30X20X44 BS300 NC FOSFATATO	SPACER. DIA 20X30X44		
326405	DISTANZIALE PIANO APP.BS350/60 AFI-NC	BS350/60 SUPPORT BASE SPACER		
327118	DISTANZIALE PUL.D.35X42 BS280	PULLEY SPACER D.35X42 BS280		SCHEIBE DISTANZSTUECK D35X42
327125	DISTANZ.PUL.30X20X10 BS300 NC FOSFATATO	SPACER, DIA 30X20X10		
327198	DISTANZIALE ENCODER 280/60 NC 20X11X75 FOSFATATO	-		
330010	ESAGONO ATT.SPAZ.D100 BS350	HEXAGONAL BRUSH CONNECTION	HEXAGONAL POUR BROSSSE D100	SECHSKANTIGER BUERSTEANSCHLUSS
331524	EL.POMPA LUNGA AST60 PIEDE=150 230400V 1/2"- W120=PMU60LP170	LONG ELECTRIC PUMP 230400	POMPE 331524	
331770	ENCODER EL40A2000Z5/28P6X3PR 006 MT.4 CAVO INCREMENTALE	ENCODER EL40A 2000Z5/28 C6X3PR		
331775	ESAGONO MASC.ALLIN.AVANZ/MACCH INA	HEXAGON.SPACER FOR FEEDER,MALE		
331790	ESAGONO FEM.ALL.AVZ.BS350 POST ERIORE	HEXAGON.FEEDER SPACER, FEMALE		
331925	FASCETTA TUBO TORRO S 12-22/9 C7 W1	HOSE CLAMP W2 12-20		SCHLAUCHSCHELLE W2 12-20
332465	FERMO X ROTAZ.MORSA BS350/60 A FI-NC LAVORATO			
344193	FLANGIA D.80 BLOCC.RASCHIATORI AVANZAT.	FLANGE D.80 FOR FEEDER SEALS		
349351	FLANGIA RIDUT/MOTORE BS350 LAVORATA	MOTOR/REDUCTION FLANGE BS350		MOTOR/REDUKTIONSGETR.FL ANSCHUE
349353	FLANGIA VITE SENZA FINE BS350	ENDLESS SCREW FLANGE BS350		ENDSCHALTER SCHRAUBE BS350
486550	GANASCIA CARREL.MORSA BS350/60	BS350/60 VICE JAW CARRIAGE		
490785	GANASCIA CHIUS.AVANZ.BS350/60 TEMPRATA RIGATA	BS350/60 JAW ENCLOSE FEEDER		
490865	GANASC.APP.AVANZATORE BS350/60	BS350/60 JAW SUPPORT FEEDER		
491050	GANASCIA PRES.MORSA BS350 AFI- E	VICE PRESSURE JAW BS350AFI		
492630	GANASCIA AP.SIN.350/60AFIE NEW AUT	BS350/60 JAW SUPPORT LEFT NEW		

ISTRUZIONI PER L'USO

497200	GHIERA KM7 M35x1,5 VTF 500	RING KM7 M35X1,5		NUTMUTTER KM7 M35X1,5 VTF500
497303	GHIERA KM9 M45X1,5	LOCKING RING KM9 M45X1,5		NUTMUTTER KM9 M45X1,5
497483	GHIERA KM10 M50X1,5 BS350	RING KM10 M50X1,5 BS340PR		NUTMUTTER KM10 M50X1,5 BS340PR
499805	GHIERA GP PESANT.M20X1 AUTOBLO CCANTE	RING M20X1		
499850	GHIERA GP PESANT.M45X1,5 AUTOB LOCCANTE	RING M45X1,5		
500283	GIUNTO X ENCODER D.6 NYLON XT4 10 OMRON E69- C06B	COUPLER D.6 NYLON		
510200	GUARNIZIONE EL.POMPA D.130X102 X2 GOMMA ANTIOLIO	ELECTROPUMP SEAL D.130X102		
510290	GUARNIZIONE CARTA RIDUTT.BS350	REDUCTION GASKET BS350		REDUKTIONSDICHTUNG BS350
511144	GUARNIZIONE PARAP.AS40- 50-5-8	ANTIDUST GASKET AS40-50-5- 8		
511163	GUARNIZIONE RS3240 CIL. IDR.KS	PISTON SEAL RS3240		
511290	GUARNIZ. IDROSTOP DBM196133/M BS350/280 D50XD34X20.5	SAW FR.CYL.GASKET MDB2X400501		
512499	GUIDA HIWIN HGR15R420C BS350 (FORI20 E 40 MM)TASTATORE	GUIDE HIWIN LGR15R417C 20/37		
514762	IMPUGNATURA SFERA NERA D.30-M8 (MONT.FILETT.)	BLACK HANDLE DIA. 30-M8		
515753	INGRASSATORE M8 CH10 SFERA+MOL LA L1	OILER M8 CH10		
515780	INSERTO SPECIALE D15.95X6.4 BS350	SPECIAL INSERT D15,95X6,4	PLAQUETTE SPECIALE D15,95X6,4	
515800	INSERTO QUADRO SVAS.19,3X4 F.4 WXP0274=GATTIA191DB10.OD C4.2G	SQUARE CARBURE PAD 19,3X4 F.4	PLAQUETTE CARBURE 19,3X4 F.4	VIERECKIGER EINSATZ 19.3X4 F.4
520765	INTER.SICUR.FK3393-D1 CHIAV.90 °PIZZATO	SAFETY SWITCH FK3393-D1		
520941	FINCORSA LEVA ABV121260 NAIS= OMRON D2VW5L1B1M- BS-230	STROKE-END ABV161660		
521000	INTER.FINCORS=TELEMEC.XC MA1032 CAVO 2M,RUOTA 90°E700-0-BM/90	STROKE END SWITCH TELEMEC.	FIN DE COURSE	
521134	INTERR.PROSSIM.IS61= 10- 30V DC D.12 NPN/NO=(TLCC12/4 NPN/NA)	PROXIMITY SWITCH TLCC12/4		
521145	INTER.FINCORS=TELEMEC.XC MA1023 CAVO 3M,RUOTA DIR.E700-0-BM/3	STROKE END SWITCH TELEMEC.	FIN DE COURSE	ENDSCHALTER TELEMEC. XCMA1023
521210	INVERT.2,2KW ATV31HU22N4 TR400 TELEMECANIQUE 380>460V 50/60H	INVERTER ATV-31HU22N4 400V		
521255	INVERT.0,75KW ATV- 31H075M2 MON O TELEMECANIQUE 230V 50/60HZ	INVERTER 0,75KW ATV- 31H075M2		
521580	LACCIO LEGRAND 320-32 2,4X180	LEGRAND PLASTIC STRING		
521585	BASE A INCASTRO 320.76 X LACCI LEGRAND	SUPPORT FOR STINGS 320.76		
521652	LAMIERA BLOCC.TUBI OLIO BS350	OIL HOSES SUPPORT FOR BS 350		
521723	LAMIERA FC FINEBARRA BS300 NC	NEWAUT. SHEET X STROKE- END		
521873	LAMIERA COM.EL.NEWAUT. (NEW10)	EL.CONTROL SHEET METAL NEWAUT.		
521945	LAMIERA DX.SCARICO NEWAUT 350	UNLOAD IRON JAW NEWAUT 350		
522100	LAMIERA FISS.MOLLE RIDUT.BS350	REDUCTION SPRINGS FIXED GUARD		BLECH FUER FIX.FEDER/REDUKTION
522105	LAMIERA ATTACCO MOLLE BS350GH	SPRINGS CONNECTION GUARD 350SH		
522387	LAMIERA COPRI VITE AV.NEWAUT	-		

ISTRUZIONI PER L'USO

522592	LAMIERA X PIANO GIR.BS350/60AF I-NC	SHEET X BS350/60 AF PLATFORM		
522598	LAMIERA X RISC.350/60AFIE NEWA UT	SHEET X VICE BS350/60 NEW		
522623	LAMIERA SOST.SCIV.NEWAUT 350	UNLOADER SUPPORT PLATE NEW 350		
522630	LAMIERA PORTA TUBI RIDUT.BS350	TUBE SUPPORT FOR BS 350		ROEHRENTRAGER FUER BS350
522924	LAMIERA "L" FERMO TASTATORE	-		
522941	LAMIERA TASTATORE BS300	-		
532470	MANICOTTO PN. M/4 FEMM.	PNEUMATIC COUPLING M/4		
535032	MANIGLIA "U" NERA ART.1102BOM8 =M243/140	BLACK HANDLE 1102BOM8		
536419	MANIGLIA RIPRESA M8X20 TIPO 63 BRACCIO COM. 280 AFI-E	HANDLE M8X20 TYPE 63		HANDGRIFF M8X20 TYP 63
536630	MANIGLIA RIPRESA M12X35 TIPO 8 0 NERA PLT	HANDLE M12X35 TYPE 8		
536675	MANIGLIA RIPRESA M12X45 TIP.80 MASCHIO	TURNING HANDLE M12X45 TYPE 80	POIGNEE M 12X45	DREHEBARER HANDGRIFF M12X45 80
539877	MANOM.GLIC.113-13-063 40BARPSI (PER IDRAULICA)	MANOMETER 113-13-063 40BARPSI	MONOMETRE 113-13-063	MANOMETER 113-13-063 40BARPSI
544800	MOLLA GAS 082597 SIR/VEL.AF-E	GAS SPRING 082597 SIR/VEL AF-E		GAS FEDER 082597 SIR/VEL AF-E
546938	MOLLA TAZZA 40X20,4X2,5 MANDRI NO/PULEGG.	SPINDLE CUP SPRING 40X20,4X2,5	RESSORT 40X20,4X2,5	SPINDEL FEDERING 40X20,4X2,5
546957	MOLLA TAZZA 31,5X16,3X2 TENDIN AST.BS280	CUP SPRING 31,5X16,3X2	RESSORT 31,5X16,3X2	TELLERFEDER 31,5X16,3X2
546969	MOLLA TAZZA 25X12,2X1,5	CUP SPRING 25X12,2X1,5		TELLERFEDER 25X12,2X1,5
547200	MOLLA COMPR.12X19X2 POS17CO183 BS350	SPRING 12X19X2		FEDER 12X19X2 POS17CO183
547210	MOLLA COMPR.14,5X22X2 CO186P29 BS350 SPAZZOLINO	SPRING 14,5X22X2		FEDER 14,5X22X2
547265	MOLLA COM.16,5X3X35 PS39 CO091	SPRING 16,5X3X35		
547268	MOLLA COMPR.15X58X1.2 POS189 XT320 MCO-33	SPRING 15X58X1.2		
547316	MOLLA NASELLO BASAM.BS280/350	BASE SPRING BS280PLUS/340/350		GRUNDLAGE NASE FEDER BS280/350
547652	MOLLA PER ARCO BS230-280- 350-3 40	SAW FRAME RETURN SPRING 340280	RESSORT RAPPEL ARCHET BS340-BS	RAHMEN RUECKFEDER BS340-BS280
589250	MOT.3F 4P TIP.80+TP B14 KW0,75 KW 400/230AUTOF.FRENO CC 24VD	3PH MOTOR TIP.80+TP B14 KW0,75		-
589280	MOT.3F 4P B14+VENT.MONOF BS350 *1,8*V400/230 SENZA CHIAV.FC9	3PH MOTOR+FAN B14 4P BS350 1,8		
614515- 5/7	NASTRO"350"3370X27X09 M42SVGLB (STB)DENTATURA=5/7 HV950	BAND 3370X27X09 SVGLB M42 5/7	RUBAN BS350 3370X27X09 STB 5/7	
616170	NIPPLO N4-4 1/4"A1/4" OTTONE	BRASS THREADED CONNECTION M4-4		MESSING NIPPEL M4-4 1/4"
616230	NIPPLO OLIO 1/4"X3/8"BSP RACC PER TUBO R6(CON FEMMINA 3/8")	OIL THREADED CONNECTION 1/4	616517	OEL NIPPEL 1/4" X 3/8"
616500	NIPPLO OLIO BSP 3/8" X 3/8" F113R-110 (BS350 AFI-E)	OIL THREADED CONNECTION 3/8		
616628	NIPPLO 1/2"X 1/2"ACCIAIO ZINC.	CONNECTION 1/2"X 1/2"		VERZINKTER NIPPEL 1/2"X 1/2"
628489	PALETTA ARCOGIU FINE TAGLIO (MACCHINE CON TASTATORE)	STROKE-END PLATE BOW DOWN		
629281	PANNELLO FRONT.COM.NEWAUT/SAW2	FRONT PANEL FOR NEWAUT/SAW2		
630632	PASSACAVO A MEMBRANA DG9 D.15	DIAPHRAGM CABLE GLAND DG9		
630975	PASSACAVO SCATTO SB1750- 22 NER O 145051	CABLE GLAND SB1750-22		
631095	PATTINO GUIDALAM.POST.BS350 LA VORATO	BACK BAND GUIDE BS350		HINTERER BANDFUEHRUNGSSCHUH

ISTRUZIONI PER L'USO

631097	PATTINO GUIDALAM.ANT.BS350 LAV ORATO	FRONT BAND GUIDE BS350		VORDERER BANDFUEHRUNGSSCHUH
631150	PATTINO POSTER.COMPLETO BS350	LOWER BAND GUIDE BS350		HINTERER BANDFUEHRUNGSSCHUH
631155	PATTINO ANTER.COMPLETO BS350	FRONT BAND GUIDE BS350		VORD.BANDFUEHRUNGSSCHUH K.BS350
632425	PASTIGLIA D.10 NYLON	NYLON SPACER D.10		
632788	PASTIGLIA D.10 OTTONE	BRASS. SPACER D.10		MESSING DISTANZSTUECK D.10
640800	PERNO X POSIZ.AVZ BS300NC ANTE RIORE			
640802	PERNO X POSIZ.AVZ BS300NC POST ERIORE			
646550	PERNO ATTACCO MOLLE L90 BS350	SPRINGS CONNECTION PIN L.90		FEDER VERBINDUNG STIFT L.90
651530	PERNO OSCILLANTE BS350	OSCILLATING PIN FOR BS 350		SCHWINGENDER STIFT FUER BS350
652795	PERNO CENTRALE PIAT. BS350/60 (D100X190)	PLATFORM CENTRAL PIN BS350/60		GRUNDLAGE MITTELSTIFT BS350/60
654620	PIANO GIREV.BS350/60 NC LAVORATO	BS350/60 NC WORKED ROUND SIDE		
654645	PIASTRA MOT/AVANZ.BS300AFI-NC	MOTOR FEEDER SPLATE NEW280NC		
654659	PIASTRA ATT.CHIOC.AVZ.BS300 NC (SAW2++)			
654710	PIASTRA FISS.RIDUT.PIATT.BS350	REDUCTION PLATE BLOCKING PLATE		GRUNDLAGE REDUKTION FESTPLATTE
658305	PIASTRINA SLITTA MOBILE AVANZA TORE	FEEDER MOVING PLATE		
658310	PIASTRINA SLITTA MOBILE AFI-E	MOVING SLIDE PLATE AFI-E		
658324	PIASTRA TASTATORE BS300	APPROACHING PLATE BS280		BANDSPANNERFUEHRUNGSP LATTE
658340	PIASTRA GUIDATENDINASTR.300350 FRONTALE	BAND TENSIONING GUIDE PLATE BS		BANDSPANNERFUEHRUNGSP LATTE
658612	PIASTRA SUP.FERMO ROT.BS350/60 AFI-NC LAVORATO	BS350/60 UPPER STOPLENGH PLATE		
658663	PIASTRA TENDINASTRO ANT.80X20 BS280	FRONT BAND TENS.PLATE 80X20		VORDERE BANDSPANN.PLATTE 80X20
661900	PIASTRINA X FINC.PATT.INF.VTF NUOVO	PLATE FOR LOWER BANDGUIDE VTF		
661915	PIASTRINA FINC.NASTRO NEW 2XM3 10X2X35 BRUNITA	PLATE FOR BANDSTRETCHER 2XM3		
661920	PIASTR.BLOCC.SPAZZOLINO PLUS60 (BS280 PLUS 60 GRADI)	BRUSH LOCKING PLATE BS280/60PL		
673860	PIASTRINA FINCORS.PATT.SUP.VTF 500 (LAMIERA)	BANDGUIDE STROKE-END PLATE		
681500	PIATTAF.GIREVOLE BS350/60LAVORATO X NC	BS350/60WORKED REVOL.PLATEFORM		
687010	PIATTO SLITTA MOBILE 45X443X15 AVANZAT.IMET (2 PEZ. X CODICE	MOVING SLIDE PLATE 45X443X15		
688794	PIATTO GUIDALAMA ANT.SCOR.350	MOVING FRONT BAND GUIDE PLATE		VORD.VERSCHIEB.BANDFUEH .PLATTE
690814	PISTOLA X REFRIG.ART.8966+RACC Q8606	COOLANT SPRAY GUN	PISTOLET LAVAGE	KUEHLMITTELPISTOLE + ANSCHLUSS
694925	PORTAGOMMA 1/2"M X TUBO D.14 DIRITTO	RUBB.HOSE CONNECTOR D.14X1/2"		HYDR.ANSCHLUSS F.SCHLAUCH D.14
695020	PORTAGOMMA PG8-3 D.8 INT.X3/8" DIRITTO	RUBB.HOSE CONNECTOR PG8-3 D.8		PG-VERSCHRAUBUNG 3/8" PGB-3 D8
696080	PORTAGOMMA NYLON GES6 R1/8	NYLON RUBB.HOSE CONNECTOR GES6		
696224	PORTAGOMMA NYLON WES8 R1/8 GOM ITO	NYLON RUBB.HOSE CONNECTOR R1/8		
696346	PORTAGOMMA NYLON WES8 R1/2 GOM ITO	NYLON PUSH-ON CONNECTOR R1/2		NYLON ANSCHLUSS R1/2 KNIE
697300	PORTA PLACCHETTE PATTINO BS350	PAD SUPPORT FOR BAND GUIDE 350		EINSATZLAGER FUER BANDFUEHRUNG

ISTRUZIONI PER L'USO

699580	PORTA FINCORS/MOLLE NASTRO 280 350 FRONTALE	BAND FRONT STROKE-END HOLDER		BAND VORD. ENDSCHALTER TRAGER
699591	PORTA FINCORS.ARCO FINE TAGLIO (MACCHINE CON TASTATORE)	STROKE-END HOLDER NEWAUT		ENDSCHALTER TRAGER NEWAUT
700793	PROLUNGA BSP 1/4"M X 1/4"F L17 GMFF-106	HEXAGONAL EXTENTION 1/4"MX1/4F		
707220	PULEGGIA MOTRICE D.360(350/450)	PULLEY D.360 BS350		SCHEIBE D.360 BS350
707235	PULEGGIA CONDOTTA D360(350/450)	PULLEY D.360 BS350		SCHEIBE D.360 BS350
707277	PULEGG.SUPERTORQ. STPDB22M20+ BUSS CON.BC2520F19 280 AFI NC			
707278	PULEG.SUPERTORQ.STPD 72S8M20+ BUSS.CON.BC5030F20 280 AFI NC			
716145	RACCORDO GOMITO G- 4MF=5020A1/4	ELBOW CONNECTION G- AMF=5020A1		KNIEVERBINDUNG G- AMF=5020A1
716823	RACC.OLIO DIR.D.6 1/4"CIL=E211 -106S	OIL CONNECTION D.6 1/4"		
716834	RACC.OLIO DIR.D.8 1/4"CIL.E211 -108L	OIL CONNECTION D.8 1/4"CILE211		OELLEITUNG D.8 1/4" CILE 211
718999	RACC.OLIO GOM.D.8 1/4"CON.E231 -208L	OIL CONNECTION D.8 1/4"CON.		
719061	RACC.OLIO GIR.D.8 1/4"CIL.E321 -108L=TN131	OIL CONNECTION D.8 1/4"CILE321		
719073	RACC.OLIO DIR.D.6 1/8"CON.	OIL CONNECTION D.6 1/8"		
719108	RACC.OLIO GOM.BSP F91-110 3/8- 3/8 (BS350 AFI-E)	OIL CONNECTION 3/8" F91-110		
722000	RACCORDO 3VIE 1/2"FEMM.ACC.ZIN CATO	3WAY CONNECTION 1/2"		3WEGE VERBINDUNG 1/2" NUT
722172	RACCORDO "T"1/2"FEMM.ACC.ZINC.	CONNECTION "T" 1/2"		
722345	RACCORDO T-4FFM-L=4050 DA 1/4"	CONNECTION T-4FFM-L=4050 1/4"	2	T-VERBINDUNG 4FFM-L 1/4"
723234	RACCORDO T-FFF BSP 3/8" ATFFF-110	CONNECTION 3/8" ATFFF-110		
727044	REGOLAT.IDR.ARON TIPO 2 COMPL. ALL.USO:BS280/350 SHIE+AFIE+N	CMP.UNIT SPEED REGULATOR ARON		
727299	RIDUTTORE X ARCO BS350 LAVORAT A	FRAME REDUCER BS350		REDUKTION FUER RAHMEN BS350
727513	RIDUZ.OLIO 3/8"F-1/4"M BSP	REDUCTION 3/8"FX1/4"M BSP		
727801	RIDUZ.EL.PG16 M-PG13,5 F TIPO TX RPP43 SACCHI	REDUCTION PG16M PG13.5F		
728544	RIPARO ANTERIORE NASTRO BS350	FRONT BAND COVER BS350		VORDERES BANDSCHUTZGEHAUSE
730000	RIPARO VITE MORSA BS350/60AFI- NC TPN25	BS350/60AFI SCREW VICE GUARD		
732913	RISCONTRO SCAR.PEZZ.BS350/60AF I-NC	BS350/60AFI PCS UNLOAD.		
734694	RONDELLA RAME 1/4	COPPER WASHER 1/4		
734698	RONDELLA RAME 1/8	COPPER WASHER 1/8		
735602	RONDELLA APPOGGIO SS22X32X2 DIN 988 HRC45	SUPPORT WASHER SS22X32X2		AUFLAGE-FEDERRING SS22X32X2
735902	RONDELLA PULEGGIA POSTER.BS350	BACK PULLEY WASHER BS350	RONDELLE PULIE POSTER. BS350	HINTERE SCHEIBE FEDERRING BS35
736000	RONDELLA POLIURET.ARANCIO D.47 VITE AVANZ.NC	WASHER D.47 BS340PR		
736006	RONDELLA D.51,5 VITE BS300 NC			
736230	RONDELLA MOB.PRES.MORSA BS350A FI- E	VICE WASHER BS350AFIE		
736250	RONDELLA FIS.PRES.MORSA BS350A FI-E	VICE WASHER BS350AFIE		
738976	RONDELLA 45X12X5 BRUNITA	WASHER 45X12X5		FEDERRING 45X12X5
741509	RONDELLA APPOGGIO SS20X28X2 DIN 988 HRC45	SUPPORT WASHER SS20X28X2	RONDELLE VOLANT SS20X28X2	DICHTRING SS20X28X2
742333	RONDELLA 45X35X10,5	WASHER 45X35X10,5	RONDELLE 45X35X10,5	FEDERRING 45X35X10,5

ISTRUZIONI PER L'USO

	SVASATA			
742431	RONDELLA 35X10X6 BRUNITA	BURNISHED WASHER 35X10X6		
744045	RONDELLA SPECIALE D.20X5 BRUN.	SPECIAL BURNISHED WASHER 20X5	RONDELLE D.20X5	SPEZIALUNTERLEGSCHIEBE D.20X5
744190	RONDELLA CARTER D.20X8X8 P.300 BRUNITA	BLADE GUARD WASHER D.20X8X8		
744550	RONDELLA APPOGGIO SS13X19X1,5 DIN988 HRC45 AVANZAT.280AFIE	SUPPORT WASHER SS13X19X1,5		AUFLAGE FEDERRING SS13X19X1,5
744611	RONDELLA STAMPATA 5X15X1,2	PRINTED WASHER 5X15X1,2		
744715	RONDELLA STAMPATA 6X18X2	PRINTED WASHER 6X18X2		GEDRUECKTER FEDERRING 6X18X2
744820	RONDELLA STAMPATA 8X24X2	PRINTED WASHER 8X24X2		
744987	RONDELLA STAMP.12X30X4 BRUNITA	PRINTED WASHER 12X30X4		GEDRUCKTER FEDERRING 12X30X4
744998	RONDELLA STAMPATA 14X35X3	PRINTED WASHER 16X40X3,5		
755801	RUBINETTO ART.6310 1/8"MF (DISTR.REFRIG.280 AFIE)	COCK 6310 1/8"MF		HAHN 6310 1/8"MF
755888	RUBINETTO SFERA ART.400 1/4"FF FEM/FEM (ART.6300 - 1/4"FFAGNE	COCK ART.400 1/4" FEM/FEM.		
755901	RUBINETTO SFERA ART.405 3/8"MF	COCK ART.405 3/8"	ROBINET ART.405 3/8" MF	
755995	RUBINETTO SFERA ART.405 1/2"MF	COCK 405 1/2"MF		HAHN 405 1/2"MF
759110	RULLO D.40X383 AVANZATORI AFI	FEEDER SLIDE ROLLER AFI-E		
759170	RULLO AP.VERT.40x168+30xM12X20 NEWAUT	VERT.ROLLER FEEDER NEWAUT		
759501	RULLO GL/10 60Z C400 D10 S1,5 MOLLA ACC.ZINC.(RULLIERE W40)	ROLLER GL/10 60HZ C400 D10S1,5	2	ROLLER GL/10 60HZ C400 D10S1,5
763200	RUOTA TRASCINAM.SPAZZOL.BS350	BRUSH DRIVE WHEEL FOR BS 350		BUERSTE FUEHRUNGSRAD FUER BS35
773027	SCIVOLO SCARIC COL.NEWAUT.350 (05)	NEWAUT.BASE UNLOADED SHUTE 350		
778615	SFERA D.12 NASELL.PIATTAF.BS28 0/BS340	BALL D.12 BS280		KUGEL D.12 GRUNDPLATTE BS280
780850	SNODO UNIBALL SMG10 M10 MASCHI O	UNIBALL JOINT SMG10 M10		UNIBALL GELENK SMG10 M10 ZAPFE
785770	SPAZZOLA NYLON 100x20+PERNO D6 (SENZA PERNO PER BS350/KS)	NYLON BRUSH D.100X20		NYLON BUERSTE D.100X20
788270	SPINA EL.SPIROL 5X10 DIN7343	ELASTIC PIN 5X10 DIN7343		
789065	SPINA EL.SPIROL 6X20 DIN7343	ELASTIC PIN 6X20 DIN7343		
791945	SPINA CIL.8X26 DIN 1472 INTAGL I	CYLINDRICAL PIN 8X26 DIN1472		ZYL. STIFT 8X26 DIN1472
792331	SPINA TENDINASTRO BS300350 M12 D.16X290	BAND TENSIONING ROD 280350 NEW		VORDERER BANDSPANNER STIFT
792823	SPORTELLO FISSO DX.COL.BS300 A FI-E NEWAUT	FRONT FIX DOOR FOR BASE NEWAUT		
792845	SPORTELLO MOBILE COLON. NEWAUT (NEW03)	FRONT MOB.DOOR FOR BASE NEWAUT		
796801	SQUADRETTA PORTA GUAINA 1/4" BS350/60 NC NEWAUT	BRACKET 1/4"		HUELLE AUFLAGEWINKEL 1/4"
796809	SQUADRETTA PORTA GUAINA 1" FO RO D.38	BRACKET 1"		HUELLE AUFLAGEWINKEL 1"
796937	SQUADR.PORTA REGOL.VELOC.NEWAU T BS350 AFI-E	L.SQUARE SPEED REG. LOADER		-
798880	STAFFA BLOCCAG.GUIDALAMA BS350	BANDGUIDE LOCKING BRACKET BS35		BANDFUEHRUNG SPERRSTANGE BS350
799007	STAFFA CATENA AVANZ.NEWAUT350	CHAIN FIXING PLATE NEWAUT350		
799192	STAFFA X ENCODER CARRO XT410	XT410BRACKETX CARRIAGE ENCODER		
799280	STAFFA PRES.MORSA BS350	VICE PRESSURE BRACKET		

ISTRUZIONI PER L'USO

	AFI-E	BS350AFI		
800901	STRISCIA TAST.SAW2 BS280 001	LABEL		
800903	STRISCIA TAST.SAW2 BS280 002	LABEL		
851799	SUPPORTO ANTER.CILINDRO BS350	CYLINDER FRONT SUPPORT BS350		ZYLINDER VORDERAUFLAGE BS350
851801	SUPPORTO BANDIER.FINBARR.XT320	STROKE-END SUPPORT XT320		
851828	SUPPORTO GRUPPO TASTAT.BS300	-		-
851894	SUPPORTO GUIDA TASTAT.BS350			
855372	SUPPORTO X FERMO ROTA.BS350/60 AFI-NC LAVORATO	BS350/60 SUPPORT X STOP ROTAT.		
858000	SUPP/CHIOCC.AVANZ.BS350/6 OLAVO RATO X NC	BS350/60 W. SUPP/NUT FEEDER		
863150	SUPPORTO SPAZZ. SALDATO BS350 (LAMIERA+BOCCOLA)	BRUSH SUPPORT BS350		BUERSTEAUFLAGE BS350
864623	TAPPO OLIO+GUARN.1/2"CIL.=E336 FOSFATATO NERO	OIL TANK PLUG AND GASKET 1/2"		VERSCHLUSSSTOPFEN 1/2"
864724	TAPPO OLIO+GUARN.1/4"CIL.=	OIL PLUG+GASKET 1/4"		
865362	TAPPO+ASTINA ALS 2-18	PLUG+BAR ALS 2-18		
911017	TARGHET.GRAD.PIANO GIR.BS350/60 AFI-NC (60°-45° 0°)	BS350/60 GRAD.TURNING T. PLATE		-
918420	TARGHETTA ZERO PERF.REC.UNIV.	0° PLATE	ÉTIQUETTE ZERO PERF.REC.UNIV.	
918648	TASTIER.SAW2 XT320+KT+NC/0640 CEB (20I/O,2CANALEDAC+ADC+1E NC	KEYBOARD SAW2/IMET 1 ENCODER		
928521	TESTATA SUP.PRES.MORSA BS350AF I-E	VICE UPPER CONNECTION BS350AF		
928965	TESTATA ANT.AVANZ.NEWAUT.350 (07)	FEEDER FRONT HEAD NEWAUT.350		
929031	TESTATA POST.AVANZ.NEWAUT.AFNC (SAW2++)	FEEDER REAR HEAD NEWAUT. NC		
929290	TIRANTE M10X95 CENTR.IDR.AFI-E	TIE ROD M10X95 AFIE		
929342	TIRANTE M12X115 MORSA 280AFI-E	TIE ROD M12X115 FOR VICE 280AF		
929345	TIRANTE M12X140TENS.MOLL.BS350 (SARA'M12X130)	TIE ROD M12X140 BS350		
933571	TUBO R6 3/8" 4500+FEMM.REC.3/8 " 350 AFI- E	TUBE R6 3/8"		
933575	TUBO R6 3/8" 3150+FEMM.REC.3/8 " 280 AFI- E	TUBE R6 3/8" 3150		
933580	TUBO R6 3/8" 2550+FEMM.REC.3/8 " 280SHIE	TUBE R6 3/8" 2550		
933592	TUBO R6 3/8" 2860+FEMM.REC.3/8 " 280 AFI- E	TUBE R6 3/8" 2860		
933620	TUBO R6 3/8" 2000+FEMM.REC.3/8 " 280 AFI- E	TUBE R6 3/8" 2000		
933625	TUBO R6 3/8" 1500+FEMM.REC.3/8	TUBE R6 3/8" 1500		
933633	TUBO R6 3/8" 1200+FEMM.REC.3/8 " 280SHIE	TUBE R6 3/8" 1200		
933800	TUBETTO FISSAGGIO MOLLE BS350	SPRINGS FIXING TUBE BS350		FEDER BEFESTIGUNG ROEHRCHEN
935493	TUBO RETINATO 13X19 ARIANNA	PLASTIC TUBE 13X19 ARIANNA		
935500	TUBO RETINATO 8X14 ARIANNA	PLASTIC TUBE 8X14 ARIANNA		SCHLAUCH 8X14 ARIANNA
936245	TUBETTO GEMMA 8X12 = 80 GR/MT.	COOLANT HOSE 8X12		

ISTRUZIONI PER L'USO

936290	TUBO AL 360:GETTO 2828=26,5X1	TUBE 360		
936292	TUBO AL360 3/8:1PZ=13,9COD2820	TUBE 360 3/8		
936294	TUBO AL360:RAC.FIL.2840=3/8D10	TUBE 360 / 2840		
936865	TUBO R7 1/4"4300+CODOL.d8:2DIR ITTI KS450	TUBE R7 1/4" 4300		
937711	TUBO R7 3/16"1330+CODOL.d6:1DI R/1- 90"340	TUBE R7 3/16" 1330		
938500	TUBOLARE STRUTTURA ARCO BS350 100X99	TUBULAR SAW FRAME BS350		ROEHRENFOERMIGER RAHMEN BS350
940000	VALVOLA OL.RITEGNO ATOS=HR013 ARON=AM3UPA1	PILOT CHECK VALVE ATOS=HRO13		
940003	VALVOLA RIDUT.PRES.AM3VRPIM1 ARON CON VOLANTINO"PER VTF"	VALVE AM3RPPIM1		
941002	VASCA RACC.TRUCIOLI NEWAUT.350 (08)	CHIPS CONTAINER NEWAUT. 350		
956481	VITE SFERE FH2510 ISO T7 L.990 NEWAUT 280/60 NC	-		-
956843	VITE TE M14X30 SIN.SVASATA	LEFT SCREW TE M14X30	VIS GAUCHE TE M14X30	
956844	VITE TE M14X30 SIN.CL.8.8	LEFT SCREW TE M14X30 CL.8.8	VIS GAUCHE TE M14X30 CL.8.8	LINKE SCHRAUBE TE M14X30 CL.8.8
957147	VITE MORSA BS350/60 AFI-E NEWA UT	-		-
957156	VITE CHIUS.PINZA AVANZ.NEWAUT BS300/350 AFI-E-NC	FEEDER VICE CLOSIN.SCREW AFINC		VORSCHUBSCHRAUBSTOCK SCHRAUBE
958930	VITE SENZA FINE BS350	ENDLESS SCREW BS350 GH		SCHNECKE BS350
961114	VITE REGOLAZIONE M24X2 XT410	XT410 M24X2 REG. SCREW		-
964225	VOLANTINO MOLLE ART.199- 10 M12 PASSANTE BS350 GH GRAVITA'	SPRINGS WHEEL 199-10 M12		
964234	VOLANTINO 19912520H7PFT-O IMET FINITO (PRECED.GE0016A6)	WHEEL 19912520H7PFT-O		HANDRAD 19912520H7PFT-0

QUICK-USE INSTRUCTIONS FOR THE AUTOMATIC BANDSAW BS 300/60 AFI-NC AND BS 350/60 AFI-NC

1- If the machine has not been installed yet, pls. read the 2 pages regarding INSTALLATION

In order to check that the electrical supply has been connected, switch-on the oil pump by pushing the #10 push button, then push #03 or #13: if the cutting unit moves up or down everything is OK; if nothing moves, disconnect and reverse two of the wires in the plug. Remember to connect the NEUTRAL WIRE, too.

NOTE: if the emergency button is pressed, nothing moves and the display shows the error message.

2 - If you carry out correctly these operations, you can start running the saw in SEMIAUTOMATIC cycle:

Push START I to make a single cut; if everything is OK, the sawframe drops quickly until it touches the material, then slows down, makes the cut and then goes up again.

In order to start, adjust the vice position with the correspondent wheel: move it all the way against the bar and then come back by 3/4 of a round

(NOTE during the semiautomatic cycle the feeder vice is not controlled)

It is recommended to make some cuts to choose the most suited blade speed (with the buttons # 07/08) and downfeed speed with the adjustment handle (12/RI0439). Adjust then the feeder vice (buttons 01/11 to open and close it)

3 - Push PGM to access the menu of the automatic cycle, then push the button below the word NEW which appears on the display. Dial in the data on the cuts to make: to the right of the symbol L the cutting length, then confirm with ENTER; to the right side of the symbol Q the number of pieces to cut and press ENTER. Push Exit if there are no other data to store or dial in other cutting lengths and related number of cuts.

4 - If you carry out correctly this procedure, you can start working in AUTOMATIC cycle.

ISTRUZIONI PER L'USO

Push **RUN**, then the button below **RUN** and the **START** button **I** to begin the automatic cycle; if everything is OK the feeder moves backwards to clamp the material, then the cycle starts.

adjust the vice position with the wheel: move it all the way against the bar and then come back by 3/4 of a round

Verify that there is enough length of bar in order to press the bar stroke-end, then approach to the material surface the front roller leaving a few millimeter of space and block it.

(NOTE : during the automatic cycle both the feeder vice and main vice are controlled)

It is necessary to make some cuts and verify the length of the cut pieces: if they are not ok, check if there are mechanical plays on the feeding system or wrong blade thickness.

NOTE : when the bar ends, the program returns to the semiautomatic cycle. Load a new bar, then start again by pushing **PGM + RUN + I**.

If more than 5 minutes go by and no key is pushed (and the saw is not running), the electronic control switches off the hydraulic unit pump. To switch it on again, push **F10**

6 It is possible to clean the amount of pieces indicates in a program, therefore to repeat of the execution: recall the program to repeat (RUN/push-button under RUN/to select the program to repeat using the arrows) then press key **ASTERISK** up to right. The amounts of pieces come cancelled and pressing **START I** the same program is repeated.

When you put the saw on for the first time, we suggest you to do a resetting if you move the feeder when the machine is off:

With the open vices, without material, sawframe up, press **F1 -21/RI0408**-then **F1** again (the word "AZZ" compares).

When the password is required,

digit 963852, then **ENTER -29/RI0408-**. Press the button under **AUTO**, then the white button **START I**.

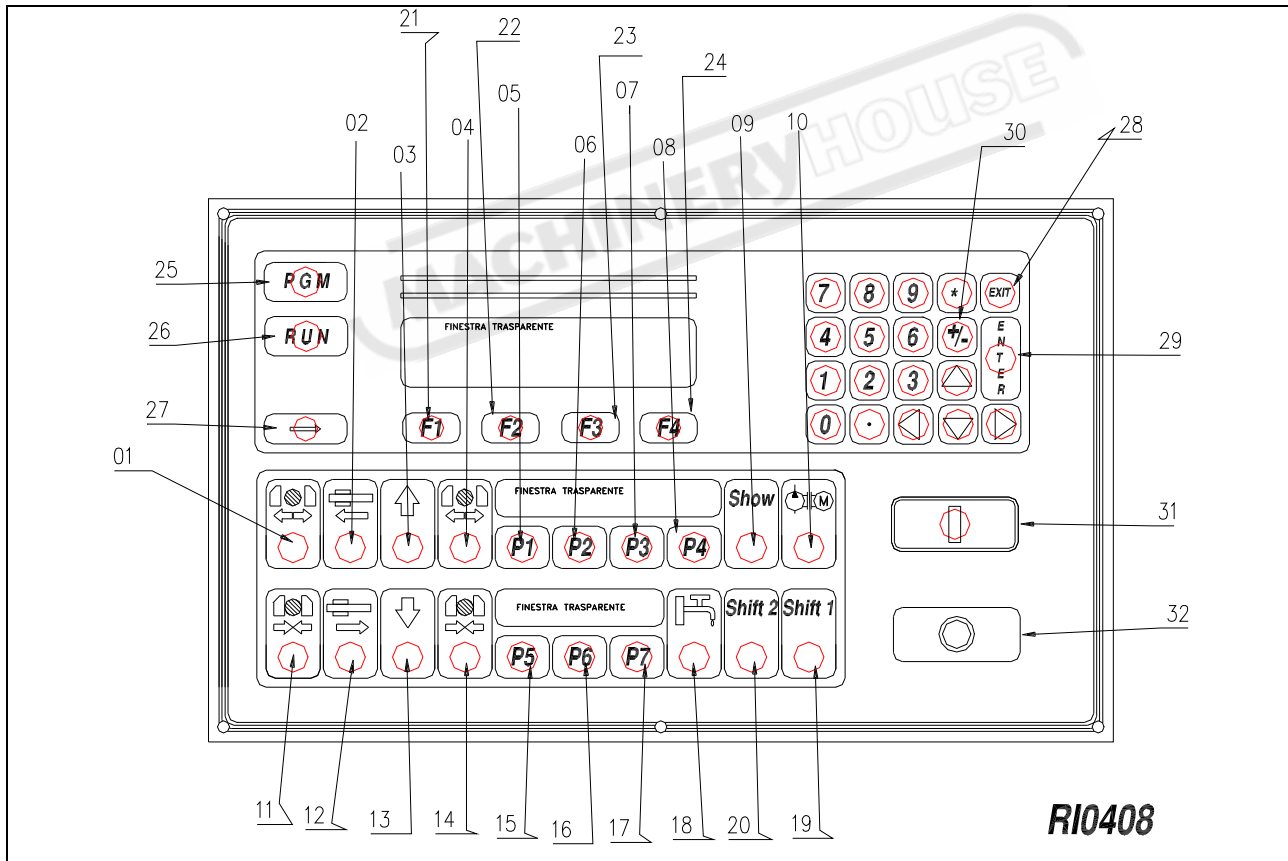



WARNING

General Machinery Safety Instructions

Machinery House
requires you to read this entire Manual before using this machine.

- 1. Read the entire Manual before starting machinery.** Machinery may cause serious injury if not correctly used.
- 2. Always use correct hearing protection when operating machinery.** Machinery noise may cause permanent hearing damage.
- 3. Machinery must never be used when tired, or under the influence of drugs or alcohol.** When running machinery you must be alert at all times.
- 4. Wear correct Clothing.** At all times remove all loose clothing, necklaces, rings, jewelry, etc. Long hair must be contained in a hair net. Non-slip protective footwear must be worn.
- 5. Always wear correct respirators around fumes or dust when operating machinery.** Machinery fumes & dust can cause serious respiratory illness. Dust extractors must be used where applicable.
- 6. Always wear correct safety glasses.** When machining you must use the correct eye protection to prevent injuring your eyes.
- 7. Keep work clean and make sure you have good lighting.** Cluttered and dark shadows may cause accidents.
- 8. Personnel must be properly trained or well supervised when operating machinery.** Make sure you have clear and safe understanding of the machine you are operating.
- 9. Keep children and visitors away.** Make sure children and visitors are at a safe distance for you work area.
- 10. Keep your workshop childproof.** Use padlocks, Turn off master power switches and remove start switch keys.
- 11. Never leave machine unattended.** Turn power off and wait till machine has come to a complete stop before leaving the machine unattended.
- 12. Make a safe working environment.** Do not use machine in a damp, wet area, or where flammable or noxious fumes may exist.
- 13. Disconnect main power before service machine.** Make sure power switch is in the off position before re-connecting.
- 14. Use correct amperage extension cords.** Undersized extension cords overheat and lose power. Replace extension cords if they become damaged.
- 15. Keep machine well maintained.** Keep blades sharp and clean for best and safest performance. Follow instructions when lubricating and changing accessories.
- 16. Keep machine well guarded.** Make sure guards on machine are in place and are all working correctly.
- 17. Do not overreach.** Keep proper footing and balance at all times.
- 18. Secure workpiece.** Use clamps or a vice to hold the workpiece where practical. Keeping the workpiece secure will free up your hand to operate the machine and will protect hand from injury.
- 19. Check machine over before operating.** Check machine for damaged parts, loose bolts, Keys and wrenches left on machine and any other conditions that may effect the machines operation. Repair and replace damaged parts.
- 20. Use recommended accessories.** Refer to instruction manual or ask correct service officer when using accessories. The use of improper accessories may cause the risk of injury.
- 21. Do not force machinery.** Work at the speed and capacity at which the machine or accessory was designed.
- 22. Use correct lifting practice.** Always use the correct lifting methods when using machinery. Incorrect lifting methods can cause serious injury.
- 23. Lock mobile bases.** Make sure any mobile bases are locked before using machine.
- 24. Allergic reactions.** Certain metal shavings and cutting fluids may cause an allergic reaction in people and animals, especially when cutting as the fumes can be inhaled. Make sure you know what type of metal and cutting fluid you will be exposed to and how to avoid contamination.
- 25. Call for help.** If at any time you experience difficulties, stop the machine and call you nearest branch service department for help.



Metal Cutting Bandsaw Safety Instructions

Machinery House
requires you to read this entire Manual before using this machine.

- 1. Maintenance.** Make sure the bandsaw is turned off and disconnect from the main power supply and make sure all moving parts have come to a complete stop before any inspection, adjustment or maintenance is carried out.
- 2. Bandsaw Condition.** Bandsaw must be maintained for a proper working condition. Never operate a bandsaw that has damaged or worn parts. Scheduled routine maintenance should be performed on a scheduled basis.
- 3. Blade Condition.** Never operate a bandsaw with a dull, cracked or badly worn blade. Before using a bandsaw inspect blades for missing teeth and cracks.
- 4. Replacing Blade.** Make sure teeth are facing the correct direction. Wear gloves to protect hands and wear safety glasses to protect your eyes.
- 5. Hand Hazard.** Keep hands and fingers clear from the line of cut of the blade and offcuts workpieces. Hands can be crushed in vice or from falling machine components and cut by the blade.
- 6. Leaving a bandsaw Unattended.** Always turn the bandsaw off and make sure all moving parts have come to a complete stop before leaving the bandsaw. Do not leave bandsaw running unattended for any reason.
- 7. Avoiding Entanglement.** Blade guard must be used at all times. Remove loose clothing, belts, or jewelry items. Never wear gloves while machine is in operation. Tie up long hair and use the correct hair nets to avoid any entanglement with the bandsaw moving parts.
- 8. Understand the machines controls.** Make sure you understand the use and operation of all controls.
- 9. Power outage.** In the event of a power failure during use of the bandsaw, turn off all switches to avoid possible sudden start up once power is restored.
- 10. Work area hazards.** Keep the area around the bandsaw clean from oil, tools, chips. Pay attention to other persons in the area and know what is going on around the area to ensure unintended accidents.
- 11. Workpiece Handling.** Workpieces must be supported with table, vice, roller conveyor/stands, or other support fixtures. Unsupported workpieces may cause the machine to tip over and fall. Flag long pieces of material to avoid tripping hazards. Never hold a workpiece with your hands during the cut process.
- 12. Hearing protection and hazards.** Always wear hearing protection as noise generated from bandsaw blade and workpiece vibration, material handling, and power transmission can cause permanent hearing loss over time.
- 13. Hot surfaces.** Workpieces, machine surfaces and chips become hot due to friction and can burn you.
- 14. Starting position.** Never turn the bandsaw on when the blade is resting on the workpiece.
- 15. Guards.** Do not operate bandsaw without the blade guard in place or with the doors open.
- 16. Call for help.** If at any time you experience difficulties, stop the machine and call your nearest branch service department for help.

PLANT SAFETY PROGRAM

NEW MACHINERY HAZARD IDENTIFICATION, ASSESSMENT & CONTROL

Metal Cutting Bandsaw

Developed in Co-operation Between A.W.I.S.A and Australia Chamber of Manufactures
This program is based upon the Australian Worksafe Standard for Plant(NOHSC.:1010-1994)

Item No.	Hazard Identification	Hazard Assessment	Risk Control Strategies <small>(Recommended for Purchase / Buyer / User)</small>
A	ENTANGLEMENT	HIGH	Eliminate, avoid loose clothing / Long hair etc.
B	CRUSHING	LOW	Secure & support Long / heavy material
C	CUTTING, STABBING, PUNCTURING	MEDIUM	Blade guards should always be in the closed position before starting machine. Blade guide system should be adjusted to suit material width. Wear gloves when changing blades. Isolate main power switch before changing blade, cleaning or adjusting. If blade breaks do not open door until both wheels have stopped. Check blade tracking before starting.
D	SHEARING	MEDIUM	Make sure all guards are secured shut when machine is on. Isolate power to machine prior to changing belts or maintenance.
F	STRIKING	LOW	Support long heavy jobs and stand clear of offcuts. Stand clear of machine when in operation. Remove all loose objects around moving parts. Wear safety glasses
H	ELECTRICAL	MEDIUM	All electrical enclosures should only be opened with a tool that is not to be kept with the machine. Machine should be installed & checked by a Licensed Electrician.
O	OTHER HAZARDS, NOISE.	LOW	Wear hearing protection as required.
Plant Safety Program to be read in conjunction with manufactures instructions			



www.machineryhouse.com.au



www.machineryhouse.co.nz

Authorised and signed by:
Safety officer:



Manager:

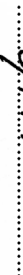

Revised Date: Aug-08